Design Example Report

Title	<i>20 W, Isolated Flyback, TRIAC Dimmable, Power Factor Corrected (>0.98) LED Driver Using LYTSwitch™-4 LYT4317E</i>
Specification	90 VAC – 132 VAC Input; 36 V, 550 mA Output
Application	PAR38 LED Driver
Author	Applications Engineering Department
Document Number	DER-350
Date	May 20, 2013
Revision	2.1

Summary and Features

- High efficiency, $\geq 85\%$ at 120 VAC
- Broad dimmer compatibility (within NEMA SSL6 dimming curves) with wide selection of U.S. TRIAC-based dimmers
- Enhanced user experience
 - Flicker free, monotonic dimming,
 - Fast monotonic start-up (<200 ms) – no perceptible delay
 - Turn on and turn off at almost the same dimming angle – no pop-on
- Low cost
 - Single-stage combined PFC and accurate primary side regulated constant current output
 - Single-sided PCB; Low component count
- Integrated protection and reliability features
 - Output open circuit / output short-circuit protected with auto-recovery
 - Fast acting line input overvoltage shutdown extends voltage withstand during line faults
 - Without MOV can withstand ± 2500 V ring wave and ± 500 V differential surge
 - Auto-recovering thermal shutdown with large hysteresis protects both components and printed circuit board
- Meets IEC 61000-4-5 ring wave, IEC 61000-3-2 C THD and IEC CISPR 15 / EN55015 B conducted EMI

Power Integrations

5245 Hellyer Avenue, San Jose, CA 95138 USA.

Tel: +1 408 414 9200 Fax: +1 408 414 9201

www.powerint.com

PATENT INFORMATION

The products and applications illustrated herein (including transformer construction and circuits external to the products) may be covered by one or more U.S. and foreign patents, or potentially by pending U.S. and foreign patent applications assigned to Power Integrations. A complete list of Power Integrations' patents may be found at www.powerint.com. Power Integrations grants its customers a license under certain patent rights as set forth at <http://www.powerint.com/ip.htm>.



Table of Contents

1	Introduction	5
2	Power Supply Specification	7
3	Schematic	8
4	Circuit Description	9
4.1	Input Filtering	9
4.2	LYTSwitch-4 Primary	9
4.3	Feedback	10
4.4	Disconnected Load Protection	10
4.5	Output Rectification	10
4.6	TRIAC Phase Dimming Control Compatibility	11
5	PCB Layout	12
6	Bill of Materials	13
7	Transformer Specification	15
7.1	Electrical Diagram	15
7.2	Electrical Specifications	15
7.3	Materials	15
7.4	Transformer Build Diagram	16
7.5	Transformer Construction	16
8	Transformer Design Spreadsheet	17
9	L1 Inductor Specification	20
9.1	Electrical Diagram	20
9.2	Electrical Specifications	20
9.3	Materials	20
9.4	Inductor Build Diagram	21
9.5	Inductor Construction	21
10	U1 Heat Sink Assembly	22
10.1	U1 Heat Sink Fabrication Drawing	22
10.2	U1 Heat Sink Assembly Drawing	23
10.3	U1 and Heat Sink Assembly Drawing	24
11	Performance Data	25
11.1	Efficiency	25
11.2	Line and Load Regulation	26
11.3	Power Factor	27
11.4	A-THD	28
11.5	Harmonic Currents	29
11.5.1	11 LED Load	29
11.5.2	12 LED Load	30
11.5.3	13 LED Load	31
11.6	Test Data	32
11.6.1	Test Data, 11 LED Load	32
11.6.2	Test Data, 12 LED Load	32
11.6.3	Test Data, 13 LED Load	32
11.6.4	120 VAC 60 Hz, 11 LED Load Harmonics Data	33
11.6.5	120 VAC 60 Hz, 12 LED Load Harmonics Data	34



11.6.6	120 VAC 60 Hz, 13 LED Load Harmonics Data	35
12	Dimming Performance Data	36
12.1	Dimming Curve with Simulated (Using Agilent 6812B AC Source) Leading Edge Dimmer	36
12.2	Fast Start-up (<200 ms) with TRIAC-Based Dimmer.....	37
12.3	Pop-on Point with TRIAC-based Dimmer	38
12.4	Output Current and Input Current Waveforms with Dimmer	39
12.6	Compatibility List	40
13	Thermal Performance.....	42
13.1	Thermal Measurement with PAR38 Lamp.....	42
13.2	90 VAC, Non-Dimming	42
13.3	132 VAC, Non-Dimming	43
13.4	120 VAC, 90° Conduction Angle	43
14	Non-Dimming Waveforms	44
14.1	Output Current and Input Current Waveforms.....	44
14.2	Output Current and Output Voltage Waveform at Normal Operation	45
14.3	Input Voltage and Output Current Waveform at Start-up.....	46
14.4	Output Voltage and Output Current Waveform at Start-up.....	46
14.5	Drain Voltage and Current at Normal Operation.....	47
14.6	Drain Voltage and Current at Start-up	48
14.7	Drain Voltage and Current at Output Short Condition	49
14.8	Open Load Condition	50
14.9	Output Diode Voltage and Current Waveform at Normal Operation.....	51
15	Conducted EMI.....	52
15.1	Test Set-up.....	52
15.2	Test Result	53
16	Line Surge	54
17	Revision History.....	55

Important Note: Although this board is designed to satisfy safety isolation requirements, the engineering prototype has not been agency approved. Therefore, all testing should be performed using an isolation transformer to provide the AC input to the prototype board.



1 Introduction

The document describes an isolated high power factor (PF) TRIAC dimmable LED driver designed to drive a nominal LED string voltage of 36 V at 550 mA typical from an input voltage range of 90 VAC to 132 VAC. The LED driver utilizes the LYT4317E from the LYTSwitch-4 family of ICs.

The topology used is a single-stage power factor corrected flyback that delivers high isolation efficiency, high power factor, low THD, and low component count.

High power factor and low THD is achieved by employing the LYTSwitch-4 IC which also provides a sophisticated range of protection features including auto-restart for open control loop and output short-circuit conditions. Line overvoltage provides extended line fault and surge withstand, and accurate hysteretic thermal shutdown that ensures safe average PCB temperatures under all conditions.

This document contains the LED driver specification, schematic, PCB diagram, bill of materials, transformer documentation and typical performance characteristics.

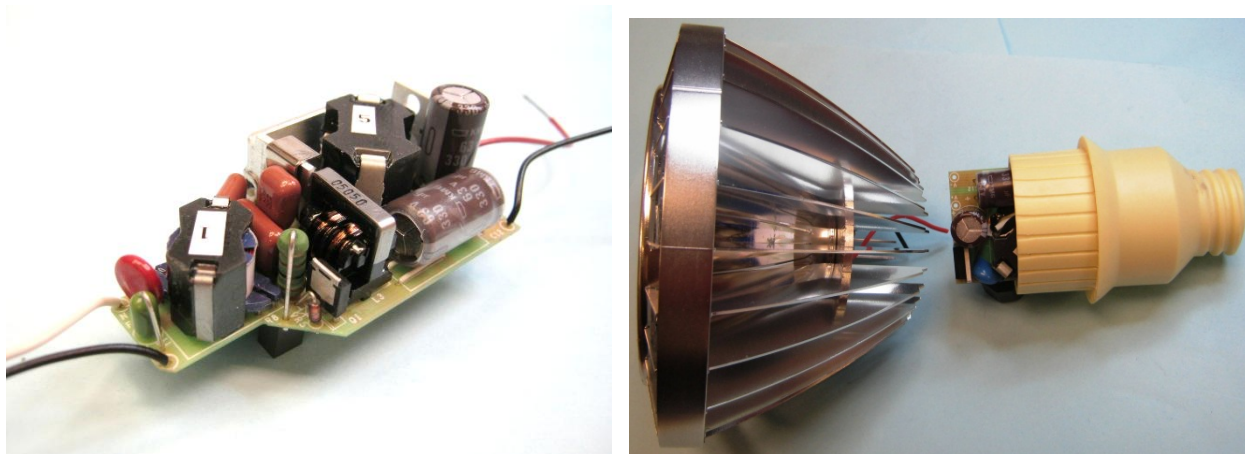

Figure 1 – Populated Circuit Board Photograph (Left) and Placed Inside a CREE PAR38 Lamp (Right).

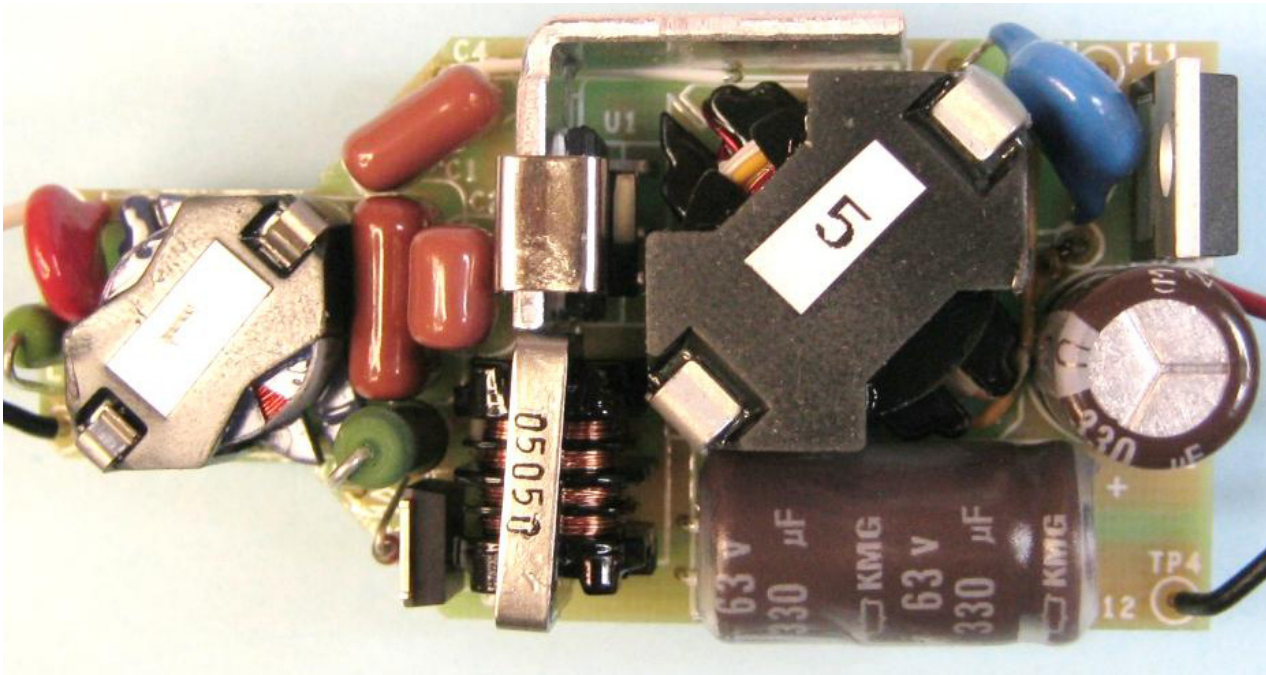

Figure 2 – Populated Circuit Board Photograph (Top View).

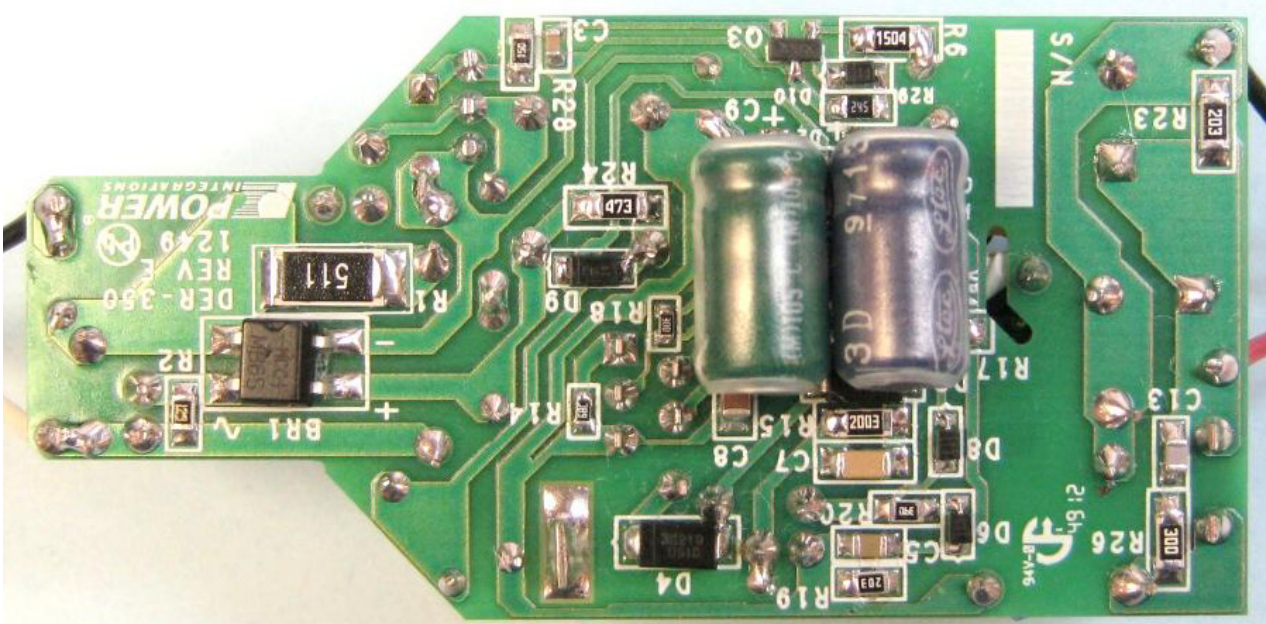

Figure 3 – Populated Circuit Board Photograph (Bottom View).



2 Power Supply Specification

The table below represents the minimum acceptable performance of the design. Actual performance is listed in the results section.

Description	Symbol	Min	Typ	Max	Units	Comment
Input Voltage Frequency	V_{IN} f_{LINE}	90	120 60	132	VAC Hz	
Output Output Voltage Output Current	V_{OUT} I_{OUT}	33	36 550	39	V mA	
Total Output Power Continuous Output Power	P_{OUT}		20		W	
Efficiency Full Load	η		85		%	$V_{OUT} = 36, V_{IN} = 120$ VAC, 25 °C ambient
Environmental Conducted EMI Safety Ring Wave (100 kHz) Differential Mode (L1-L2) Common Mode (L1/L2-PE) Differential Surge (1.2 / 50 μ s)						CISPR 15B / EN55015B Isolated 2.5 kV 500 V
Power Factor			0.97			Measured at $V_{OUT(TYP)}, I_{OUT(TYP)}$ and 120 VAC, 60 Hz
Harmonic Currents			EN 61000-3-2 Class D (C)			Class C specifies Class D Limits when $P_{IN} < 25$ W
Ambient Temperature	T_{AMB}		45		°C	Free convection, sea level



3 Schematic

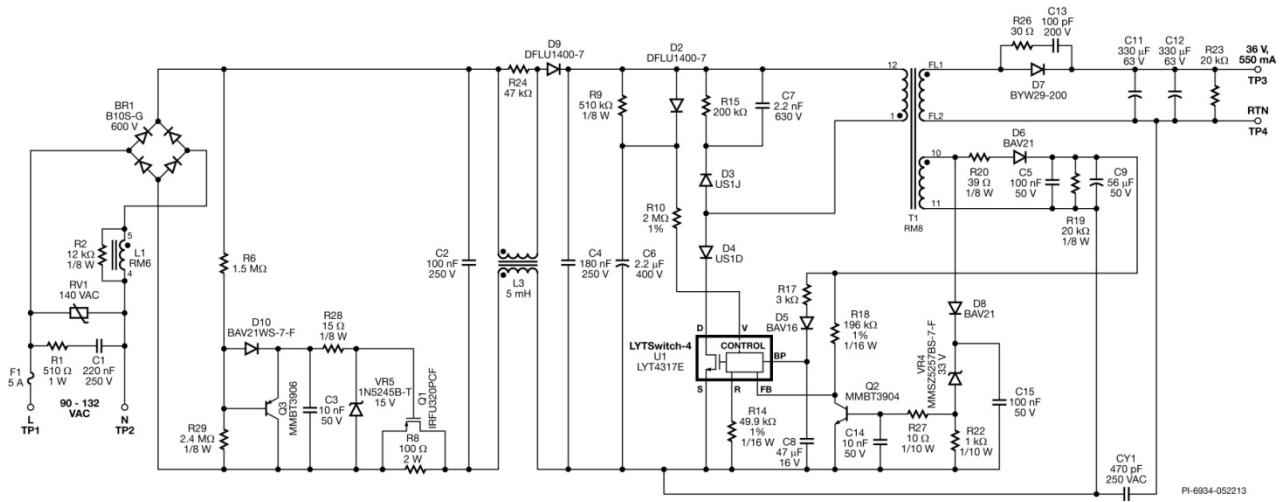

Figure 4 – Schematic.



4 Circuit Description

The LYTSwitch-4 device is a controller with an integrated 650 V power MOSFET for use in LED driver applications. The LYTSwitch-4 is configured for use in a single-stage flyback topology which provides a primary side regulated constant current output while maintaining high power factor from the AC input.

4.1 Input Filtering

Fuse F1 provides protection from component failure. A relatively high current rating was selected to prevent failure during differential (1.2 μ s / 50 μ s) line surge. The fast acting Line Over voltage detection of LYTSwitch-4 in conjunction with D2 and C6 peak detector capacitor provides a clamp to limit the maximum voltage stress across the Mosfet of the IC. Optional MOV (Metal Oxide Varistor) RV1 was used for differential line surge requirement of >500V. A 140 VAC rated part was selected, being slightly above the maximum specified operating voltage of 132 VAC. Diode bridge BR1 rectifies the AC line voltage with capacitor C4 providing a low impedance path (decoupling) for the primary switching current.

EMI filtering is provided by inductor L1, and capacitors C2, C4 and CY1. Resistors R2 and R24 across L1, and L3 respectively damp any LC resonances due to the filter components and the AC line impedance which would otherwise cause increased conducted EMI measurements.

4.2 LYTSwitch-4 Primary

One side of the transformer (T1) is connected to the DC bus and the other to the DRAIN (D) pin of the LYTSwitch-4 via blocking diode D4. During the on-time of the power MOSFET, current ramps through the primary, storing energy which is then delivered to the output during the power MOSFET off-time.

To provide peak line voltage information to U1 the incoming rectified AC peak charges C6 via D2. This is then fed into the VOLTAGE MONITOR (V) pin of U1 as a current via R10. Resistor R9 provides a discharge path for C6 with a time constant much longer than that of the rectified AC to prevent the V pin current being modulated at the line frequency (which would degrade power factor).

The line overvoltage shutdown function extends the rectified line voltage withstand (during surges and line swells) to the 650 BV_{DSS} rating of the internal power MOSFET.

The V pin current and the FEEDBACK (FB) pin current are used internally to control the average output LED current. For phase angle dimming applications a 49.9 k Ω resistor is used on the REFERENCE (R) pin (R14) and 2 M Ω (R10) on the V pin to provide a linear relationship between input voltage and the output current. This maximizes the dimming range when used with TRIAC dimmers.



During the power MOSFET off-time, D3, R15, and C7 clamp the drain voltage to a safe level due to the effects of leakage inductance. Diode D4 is necessary to prevent reverse current from flowing through U1 while the voltage across C4 (rectified input AC) falls to below the reflected output voltage (parameter V_{OR} in the design spreadsheet).

D6, C5, C9, R20 and R19 generate a primary bias supply for U1 from an auxiliary winding on the transformer. Resistor R20 provides filtering so that the bias voltage tracks the output voltage closely to maintain constant output current with changes in LED voltage. Resistor R19 discharges C9 during output short-circuit condition.

Capacitor C8 provides local decoupling for the BYPASS (BP) pin of U1 which is the supply pin for the internal controller. During start-up, C8 is charged to ~6 V from an internal high-voltage current source connected to the D pin. Once charged, U1 starts switching at which point the operating supply current is provided from the bias supply via R17.

The use of an external bias supply (via D5 and R17) is recommended to give the lowest device dissipation and provide sufficient supply to U1 during deep dimming condition.

Capacitor C8 also selects the output power mode, 47 μF was selected (reduced power mode) to minimize the device dissipation and minimize heat sinking requirements.

4.3 Feedback

The bias winding voltage is used to sense the output voltage indirectly, eliminating secondary side feedback components. The voltage on the bias winding is proportional to the output voltage (set by the turn ratio between the bias and secondary windings). Resistor R18 converts the bias voltage into a current which is fed into the FB pin of U1. The internal engine within U1 combines the FB pin current, the V pin current, and internal drain current information to provide a constant output current whilst maintaining high input power factor.

4.4 Disconnected Load Protection

In case of open (disconnected) load fault, Zener diode VR4 will conduct turning on transistor Q2. Transistor Q2 then pulls down the FB pin to force the IC into auto-restart mode. The controller annunciates both short-circuit and open-loop conditions once the FB pin current falls below the $I_{FB(AR)}$ threshold after the soft-start period. To minimize the power dissipation under this fault condition, the shutdown/auto-restart circuit turns the power supply on (same as the soft-start period) and off at an auto-restart duty cycle of typically DC_{AR} for as long as the fault condition persists. If the fault is removed during the auto-restart off-time, the power supply will remain in auto-restart until the full off-time count is completed.

4.5 Output Rectification

The transformer secondary winding is rectified by D7 and filtered by capacitors C11 and C12. For designs where lower ripple is required, the output capacitance value can be increased.



4.6 TRIAC Phase Dimming Control Compatibility

The requirement to provide output dimming with low cost, TRIAC based, leading edge phase dimmers introduced a number of tradeoffs in the design.

Due to the much lower power consumed by LED based lighting the current drawn by the lamp can fall below the holding current of the TRIAC within the dimmer. This causes undesirable behavior such as the lamp turning off before the end of the dimmer control range and/or flickering as the TRIAC fires inconsistently. The relatively large impedance the LED lamp presents to the line allows significant ringing to occur due to the inrush current charging the input capacitance when the TRIAC turns on. This too can cause similar undesirable behavior as the ringing may cause the TRIAC current to fall to zero.

To overcome these issues, active damper and passive bleeder circuits were added. The drawback of these circuits is increased dissipation and therefore reduced efficiency of the supply. For non-dimming applications these components can simply be omitted.

The active damper consists of components R6, R28, R29, D10, Q1, Q3, C3, VR5, in conjunction with R8. This circuit limits the inrush current that flows to charge input capacitors C2 and C4 when the TRIAC turns on by placing resistor R8 in series for the first ~0.5 ms of the conduction period. After approximately 0.5 ms, transistor Q1 turns on and shorts resistor R8. This keeps the power dissipation on R8 low and allows a larger value during current limiting. Resistors R6, R29, and capacitor C3 provide the 0.5 ms delay after the TRIAC conducts. Transistor Q3 discharges capacitor C3 when the TRIAC is not conducting; VR5 clamps the gate voltage of Q1 to 15 V while R28 prevents MOSFET oscillation.

The passive bleeder circuit is comprised of C1 and R1. This keeps the input current above the TRIAC holding current while the driver input current increases during each AC half-cycle preventing the TRIAC switch from oscillating at the start (and end) of each conduction angle period.



Want More?

Use your smartphone to get
related content on our website.



5 PCB Layout

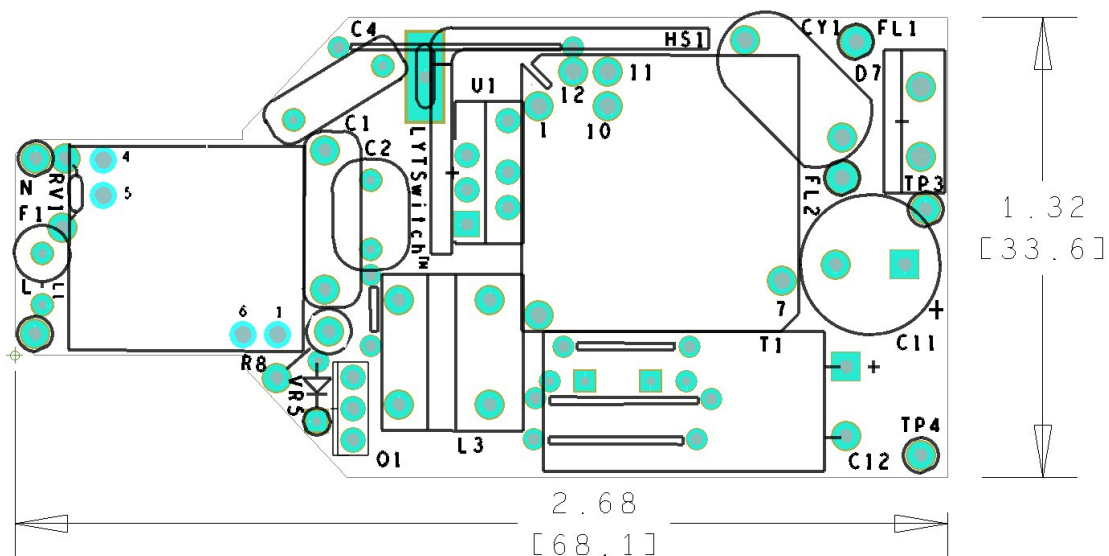

Figure 5 – Top Side.

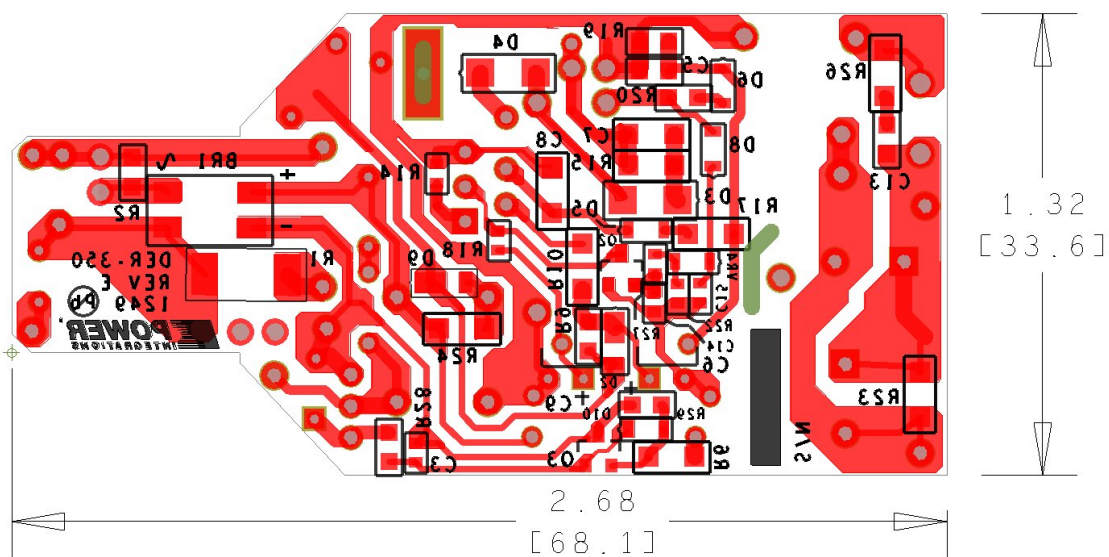

Figure 6 – Bottom Side.



6 Bill of Materials

Item	Qty	Ref Des	Description	Mfg Part Number	Mfg
1	1	BR1	1000 V, 0.8 A, Bridge Rectifier, SMD, MBS-1, 4-SOIC	B10S-G	Comchip
2	1	C1	220 nF, 250 V, Film	ECQ-E2224KF	Panasonic
3	1	C2	100 nF, 250 V, Film	ECQ-E2104KB	Panasonic
4	2	C3 C14	10 nF 50 V, Ceramic, X7R, 0603	C0603C103K5RACTU	Kemet
5	1	C4	180 nF, 250 V, Film	ECQ-E2184KB	Panasonic
6	1	C5	100 nF, 50 V, Ceramic, X7R, 0805	CC0805KRX7R9BB104	Yageo
7	1	C6	2.2 μ F, 400 V, Electrolytic, (6.3 x 11)	TAB2GM2R2E110	Ltec
8	1	C7	2.2 nF, 630 V, Ceramic, X7R, 1206	C3216X7R2J222K	TDK
9	1	C8	47 μ F, 16 V, X5R, 1206	3216X5R1C476M	TDK
10	1	C9	56 μ F, 50 V, Electrolytic, Very Low ESR, 140 m Ω , (6.3 x 11)	EKZE500ELL560MF11D	Nippon Chemi-Con
11	2	C11 C12	330 μ F, 63 V, Electrolytic, (10 x 20)	EKMG630ELL331MJ20S	United Chemi-con
12	1	C13	100 pF, 200 V, Ceramic, COG, 0805	08052A101JAT2A	AVX
13	1	C15	100 nF 50 V, Ceramic, X7R, 0603	C1608X7R1H104K	TDK
14	1	CY1	470 pF, 250 VAC, Film, X1Y1	CD95-B2GA471KYNS	TDK
15	2	D2 D9	400 V, 1 A, DIODE SUP FAST 1 A PWRDI 123	DFLU1400-7	Diodes, Inc.
16	1	D3	DIODE ULTRA FAST, SW 600 V, 1 A, SMA	US1J-13-F	Diodes, Inc.
17	1	D4	DIODE ULTRA FAST, SW, 200 V, 1 A, SMA	US1D-13-F	Diodes, Inc.
18	1	D5	75 V, 0.15 A, Switching, SOD-323	BAV16WS-7-F	Diodes, Inc.
19	3	D6 D8 D10	250 V, 0.2 A, Fast Switching, 50 ns, SOD-323	BAV21WS-7-F	Diodes, Inc.
20	1	D7	200 V, 8 A, Ultrafast Recovery, 25 ns, TO-220AC	BYW29-200G	On Semi
21	1	F1	5 A, 250 V, Fast, Microfuse, Axial	0263005.MXL	Littlefuse
22	1	L1	Bobbin, RM6, Vertical, 6 pins Inductor	B65808-N1006-D1 SNX-R1684	Epcos Santronics-USA
23	1	L3	5 mH, 0.5 A, Common Mode Choke Vertical	SU9VF-05050	Token
24	1	Q1	400 V, 3.1 A, N-Channel, TO-251AA	IRFU320PBF	Vishay/Siliconix
25	1	Q2	NPN, Small Signal BJT, 40 V, 0.2 A, SOT-23	MMBT3904LT1G	On Semi
26	1	Q3	PNP, Small Signal BJT, 40 V, 0.2 A, SOT-23	MMBT3906LT1G	On Semi
27	1	R1	510 Ω , 5%, 1 W, Thick Film, 2512	ERJ-1TYJ511U	Panasonic
28	1	R2	12 k Ω , 5%, 1/8 W, Thick Film, 0805	ERJ-6GEYJ123V	Panasonic
29	1	R6	1.5 M Ω , 5%, 1/4 W, Thick Film, 1206	ERJ-8GEYJ155V	Panasonic
30	1	R8	100 Ω , 5%, 2 W, Metal Oxide	RSMF2JT100R	Stackpole
31	1	R9	510 k Ω , 5%, 1/8 W, Thick Film, 0805	ERJ-6GEYJ514V	Panasonic
32	1	R10	2.00 M Ω , 1%, 1/4 W, Thick Film, 1206	ERJ-8ENF2004V	Panasonic
33	1	R14	49.9 k Ω , 1%, 1/16 W, Thick Film, 0603	ERJ-3EKF4992V	Panasonic
34	1	R15	200 k Ω , 5%, 1/4 W, Thick Film, 1206	ERJ-8GEYJ204V	Panasonic
35	1	R17	3 k Ω , 5%, 1/4 W, Thick Film, 1206	ERJ-8GEYJ302V	Panasonic
36	1	R18	196 k Ω , 1%, 1/16 W, Thick Film, 0603	ERJ-3EKF1963V	Panasonic
37	1	R19	20 k Ω , 5%, 1/8 W, Thick Film, 0805	ERJ-6GEYJ203V	Panasonic
38	1	R20	39 Ω , 5%, 1/8 W, Thick Film, 0805	ERJ-6GEYJ390V	Panasonic
39	1	R22	1 k Ω , 5%, 1/10 W, Thick Film, 0603	ERJ-3GEYJ102V	Panasonic
40	1	R23	20 k Ω , 5%, 1/4 W, Thick Film, 1206	ERJ-8GEYJ203V	Panasonic
41	1	R24	47 k Ω , 5%, 1/4 W, Thick Film, 1206	ERJ-8GEYJ473V	Panasonic



42	1	R26	30 Ω , 5%, 1/4 W, Thick Film, 1206	ERJ-8GEYJ300V	Panasonic
43	1	R27	10 Ω , 5%, 1/10 W, Thick Film, 0603	ERJ-3GEYJ100V	Panasonic
44	1	R28	15 Ω , 5%, 1/8 W, Thick Film, 0805	ERJ-6GEYJ150V	Panasonic
45	1	R29	2.4 M Ω , 5%, 1/8 W, Thick Film, 0805	ERJ-6GEYJ245V	Panasonic
46	1	RV1	140 V, 12 J, 7 mm, RADIAL	V140LA2P	Littlefuse
47	1	T1	Bobbin, RM8, Vertical, 12 pins Transformer	RM8/12/1 SNX-R1670	Schwartzpunkt Santronics-USA
48	1	U1	LYTSwitch-4, eSIP-7C	LYT4317E	Power Integrations
49	1	VR4	33 V, 5%, 200 mW, SOD-323	MMSZ5257BS-7-F	Diodes, Inc.
50	1	VR5	15 V, 5%, 500 mW, DO-35	1N5245B-T	Diodes, Inc.



7 Transformer Specification

7.1 Electrical Diagram

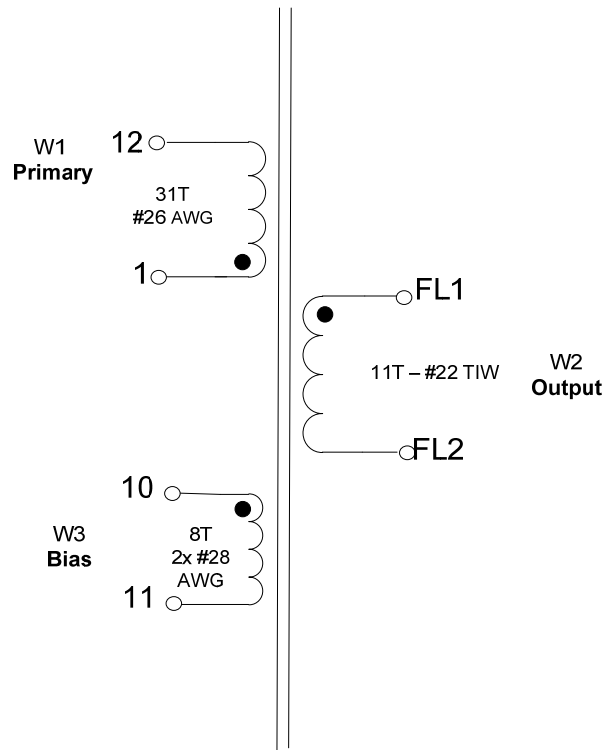

Figure 7 – Transformer Electrical Diagram.

7.2 Electrical Specifications

Electrical Strength	1 second, 60 Hz, from pins 1, 10, 11, 12 to FL1, FL2.	3000 VAC
Primary Inductance	Pins 1 and 12, all other windings open, measured at 10 kHz, 0.4 V _{RMS} .	387 μH +7%
Resonant Frequency	Pins 1 -12, all other windings open.	750 kHz (Min.)
Primary Leakage Inductance	Pins 1-12, with FL1-FL2 shorted, measured at 132 kHz, 0.4 V _{RMS} .	<10 μH

7.3 Materials

Item	Description
[1]	Core: RM8/I, 3F3.
[2]	Bobbin, 12 pin vertical, CSV-RM8-1S-12P from Philips or equivalent. With mounting clip, CLI/P-RM8.
[3]	Tape, Polyester film, 3M 1350F-1 or equivalent, 9 mm wide.
[4]	Wire: Magnet, #26 AWG, solderable double coated.
[5]	Wire: Magnet, #28 AWG, solderable double coated.
[6]	Wire, Triple Insulated, Furukawa TEX-E or Equivalent, #22 TIW.
[7]	Transformer Varnish, Dolph BC-359 or equivalent.

7.4 Transformer Build Diagram

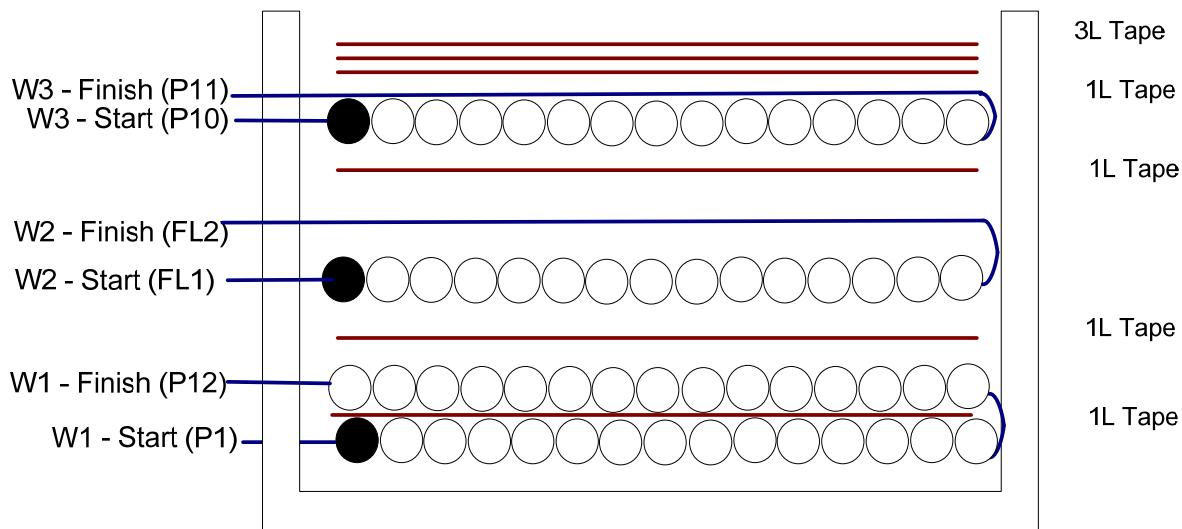

Figure 8 – Transformer Build Diagram.

7.5 Transformer Construction

Bobbin Preparation	Place the bobbin item [2] on the mandrel such that pin side on the left side. Winding direction is the clockwise direction.
WDG 1 (Primary)	Starting at pin 1, wind 31 turns of wire item [4] in two layers. Apply one layer of tape item [3] between 1 st and 2 nd layer (spread the winding evenly). Finish at pin 12.
Insulation	Apply one layer of tape item [3].
WDG 2 (Secondary)	Leave about 1" of wire item [6], use small tape to mark as FL1, enter into slot of secondary side of bobbin, wind 11 turns in one layer. At the last turn exit the same slot, leave about 1", and mark as FL2.
Insulation	Apply one layer of tape item [3].
WDG 3 (Bias)	Starting at pin 10, wind bifilar 8 turns of wire item [5], spreading the wire, and finish at pin 11.
Finish Wrap	Apply three layers of tape item [3] for finish wrap.
Final Assembly	Cut FL1 and FL2 to 0.75". Grind core to get 387 μ H inductance. Assemble and secure core halves. Dip impregnate using varnish item [7].



8 Transformer Design Spreadsheet

ACDC_LYTSwitch_101712; Rev.1.0; Copyright Power Integrations 2012	INPUT	INFO	OUTPUT	UNIT	LYTSwitch_101712: Flyback Transformer Design Spreadsheet
ENTER APPLICATION VARIABLES					
Dimming required	YES		YES		Select 'YES' option if dimming is required. Otherwise select 'NO'.
VACMIN			90	V	Minimum AC Input Voltage
VACMAX			132	V	Maximum AC input voltage
fL			60	Hz	AC Mains Frequency
VO	36.00		36	V	Typical output voltage of LED string at full load
VO_MAX	39.00		39.00	V	Maximum expected LED string Voltage.
VO_MIN	33.00		33.00	V	Minimum expected LED string Voltage.
V_OVP			42.90	V	Over-voltage protection setpoint
IO	0.55		0.55	A	Typical full load LED current
PO			19.8	W	Output Power
η	0.85		0.85		Estimated efficiency of operation
VB			25	V	Bias Voltage
ENTER LYTSwitch VARIABLES					
LYTSwitch	LYT4317		LYT4317		Selected LYTSwitch
Current Limit Mode	RED		RED		Select "RED" for reduced Current Limit mode or "FULL" for Full current limit mode
ILIMITMIN			2.35	A	Minimum current limit
ILIMITMAX			2.73	A	Maximum current limit
fS			132000	Hz	Switching Frequency
fSmin			124000	Hz	Minimum Switching Frequency
fSmax			140000	Hz	Maximum Switching Frequency
IV			79.8	uA	V pin current
RV			2	M-ohms	Upper V pin resistor
RV2			1E+012	M-ohms	Lower V pin resistor
IFB	133.00		133.0	uA	FB pin current (85 uA < IFB < 210 uA)
RFB1			165.4	k-ohms	FB pin resistor
VDS			10	V	LYTSwitch on-state Drain to Source Voltage
VD			0.50	V	Output Winding Diode Forward Voltage Drop (0.5 V for Schottky and 0.8 V for PN diode)
VDB			0.70	V	Bias Winding Diode Forward Voltage Drop
Key Design Parameters					
KP	0.97		0.97		Ripple to Peak Current Ratio (For PF > 0.9, 0.4 < KP < 0.9)
LP			389	uH	Primary Inductance
VOR	102.00		102	V	Reflected Output Voltage.
Expected IO (average)			0.55	A	Expected Average Output Current
KP_VACMAX			1.08		Expected ripple current ratio at VACMAX
TON_MIN			1.83	us	Minimum on time at maximum AC input voltage
PCLAMP			0.16	W	Estimated dissipation in primary clamp
ENTER TRANSFORMER CORE/CONSTRUCTION VARIABLES					
Core Type	RM8/I		RM8/I		
Bobbin		RM8/I_BOBBIN		P/N:	*
AE			0.63	cm^2	Core Effective Cross Sectional Area
LE			3.84	cm	Core Effective Path Length
AL			3000	nH/T^2	Ungapped Core Effective Inductance
BW			8.6	mm	Bobbin Physical Winding Width
M			0	mm	Safety Margin Width (Half the Primary to



				Secondary Creepage Distance)
L	1.50	1.5		Number of Primary Layers
NS	11	11		Number of Secondary Turns
DC INPUT VOLTAGE PARAMETERS				
VMIN		127	V	Peak input voltage at VACMIN
VMAX		187	V	Peak input voltage at VACMAX
CURRENT WAVEFORM SHAPE PARAMETERS				
DMAX		0.47		Minimum duty cycle at peak of VACMIN
I AVG		0.25	A	Average Primary Current
IP		1.29	A	Peak Primary Current (calculated at minimum input voltage VACMIN)
IRMS		0.39	A	Primary RMS Current (calculated at minimum input voltage VACMIN)
TRANSFORMER PRIMARY DESIGN PARAMETERS				
LP		389	uH	Primary Inductance
LP_TOL		10		Tolerance of primary inductance
NP		31		Primary Winding Number of Turns
NB		8		Bias Winding Number of Turns
ALG		412	nH/T^2	Gapped Core Effective Inductance
BM		2586	Gauss	Maximum Flux Density at PO, VMIN (BM<3100)
BP		3081	Gauss	Peak Flux Density (BP<3700)
BAC		1254	Gauss	AC Flux Density for Core Loss Curves (0.5 X Peak to Peak)
ur		1455		Relative Permeability of Ungapped Core
LG		0.17	mm	Gap Length (Lg > 0.1 mm)
BWE		12.9	mm	Effective Bobbin Width
OD		0.42	mm	Maximum Primary Wire Diameter including insulation
INS		0.06	mm	Estimated Total Insulation Thickness (= 2 * film thickness)
DIA		0.36	mm	Bare conductor diameter
AWG		28	AWG	Primary Wire Gauge (Rounded to next smaller standard AWG value)
CM		161	Cmils	Bare conductor effective area in circular mils
CMA		416	Cmils/Am _p	Primary Winding Current Capacity (200 < CMA < 600)
TRANSFORMER SECONDARY DESIGN PARAMETERS (SINGLE OUTPUT EQUIVALENT)				
Lumped parameters				
ISP		3.59	A	Peak Secondary Current
ISRMS		1.07	A	Secondary RMS Current
IRIPPLE		0.92	A	Output Capacitor RMS Ripple Current
CMS		214	Cmils	Secondary Bare Conductor minimum circular mils
AWGS		26	AWG	Secondary Wire Gauge (Rounded up to next larger standard AWG value)
DIAS		0.41	mm	Secondary Minimum Bare Conductor Diameter
ODS		0.78	mm	Secondary Maximum Outside Diameter for Triple Insulated Wire
VOLTAGE STRESS PARAMETERS				
VDRAIN		394	V	Estimated Maximum Drain Voltage assuming maximum LED string voltage (Includes Effect of Leakage Inductance)
PIVS		110	V	Output Rectifier Maximum Peak Inverse Voltage (calculated at VOVP, excludes leakage inductance spike)
PIVB		77	V	Bias Rectifier Maximum Peak Inverse Voltage (calculated at VOVP, excludes



			leakage inductance spike)
FINE TUNING (Enter measured values from prototype)			
V pin Resistor Fine Tuning			
RV1	2.00	M-ohms	Upper V Pin Resistor Value
RV2	1E+012	M-ohms	Lower V Pin Resistor Value
VAC1	115.0	V	Test Input Voltage Condition1
VAC2	230.0	V	Test Input Voltage Condition2
IO_VAC1	0.55	A	Measured Output Current at VAC1
IO_VAC2	0.55	A	Measured Output Current at VAC2
RV1 (new)	2.00	M-ohms	New RV1
RV2 (new)	10455.82	M-ohms	New RV2
V_OV	161.1	V	Typical AC input voltage at which OV shutdown will be triggered
V_UV	34.5	V	Typical AC input voltage beyond which power supply can startup
FB pin resistor Fine Tuning			
RFB1	165	k-ohms	Upper FB Pin Resistor Value
RFB2	1E+012	k-ohms	Lower FB Pin Resistor Value
VB1	22.9	V	Test Bias Voltage Condition1
VB2	27.1	V	Test Bias Voltage Condition2
IO1	0.55	A	Measured Output Current at Vb1
IO2	0.55	A	Measured Output Current at Vb2
RFB1 (new)	165.4	k-ohms	New RFB1
RFB2(new)	1.00E+12	k-ohms	New RFB2



9 L1 Inductor Specification

9.1 Electrical Diagram

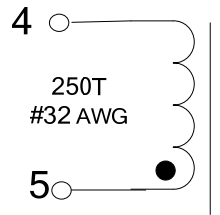

Figure 9 – Inductor Electrical Diagram.

9.2 Electrical Specifications

Primary Inductance	Pins 4-5, all other windings open, measured at 100 kHz, 0.4 V _{RMS} .	2 mH ±5%
Resonant Frequency	Pins 4-5, all other windings open.	750 kHz (Min.)

9.3 Materials

Item	Description
[1]	Core: RM6, TDK - PC40. ALG=32nH/n ² .
[2]	Bobbin: RM6-V 6 pins (3/3), PI#: 25-00039-00.
[3]	Clip: AllStar Magnetic, #: CLI-RM6/I; or equivalent.
[4]	Tape: Polyester film, 3M 1350F-1; or equivalent, 6.4 mm wide.
[5]	Wire: Magnet, #32 AWG, solderable double coated.
[6]	Varnish: Dolph BC-359 or equivalent.



9.4 Inductor Build Diagram

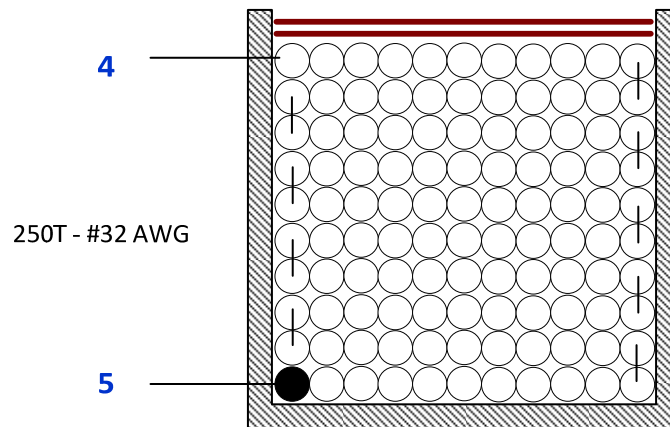

Figure 10 – Inductor Build Diagram.

9.5 Inductor Construction

Bobbin Preparation	Place bobbin item [2] on the mandrel such that pin side is on the left side. Winding direction is the clockwise direction. <u>Note:</u> pin 1 side has V notch on the top of bobbin.
Winding	Start pin 5, wind 250 turns of wire item [5] from left to right then form right to left in 10 layers, at the last turn finish at pin 4.
Finish	Apply 1 layer of tape item [4] to secure the winding. Grind both core halves to get 2.0 mH and assemble with clip item [3]. Cut pins: 2 and 3. Varnish item [6].

10 U1 Heat Sink Assembly

10.1 U1 Heat Sink Fabrication Drawing

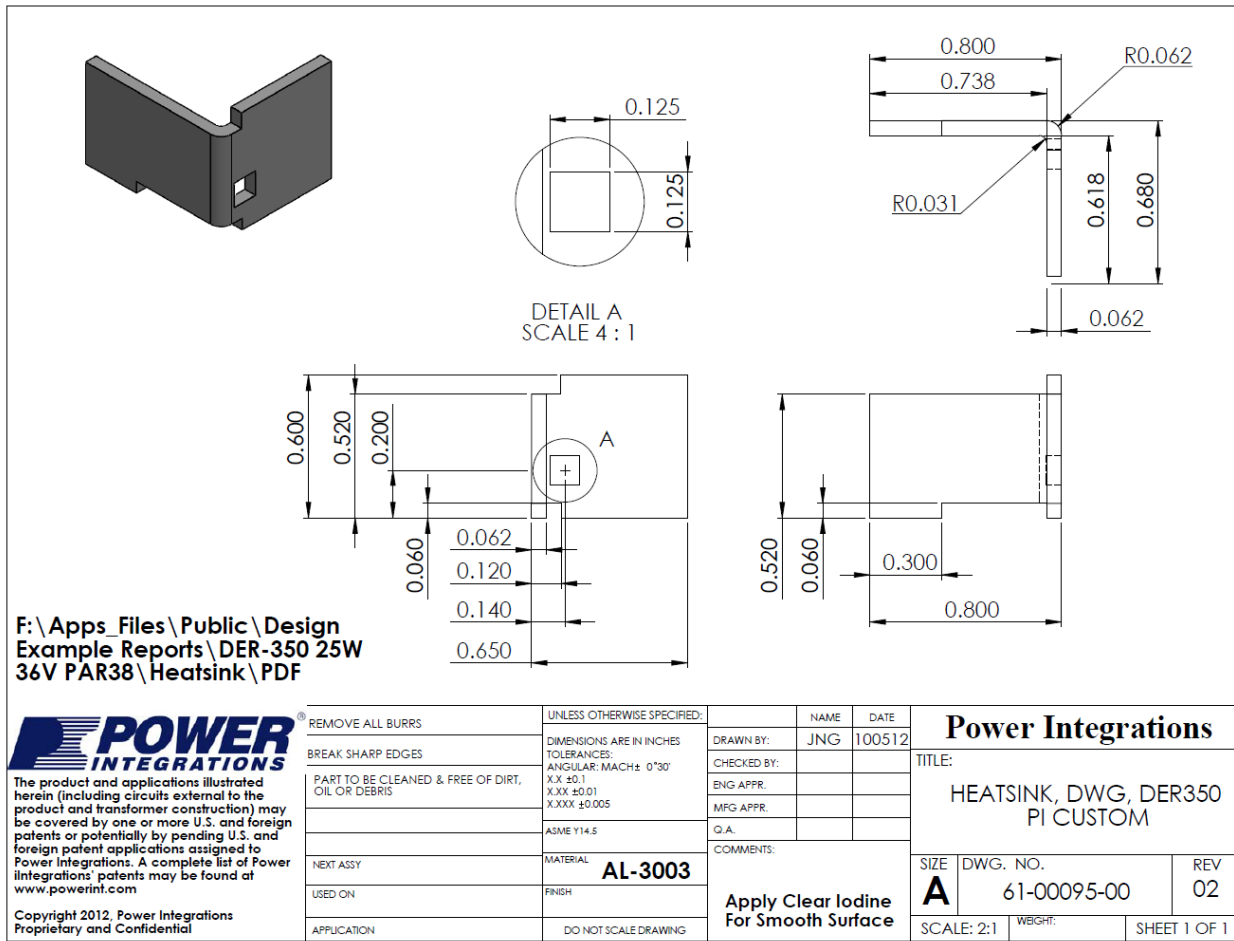

Figure 11 – Heat Sink Fabrication Drawing.



10.2 U1 Heat Sink Assembly Drawing

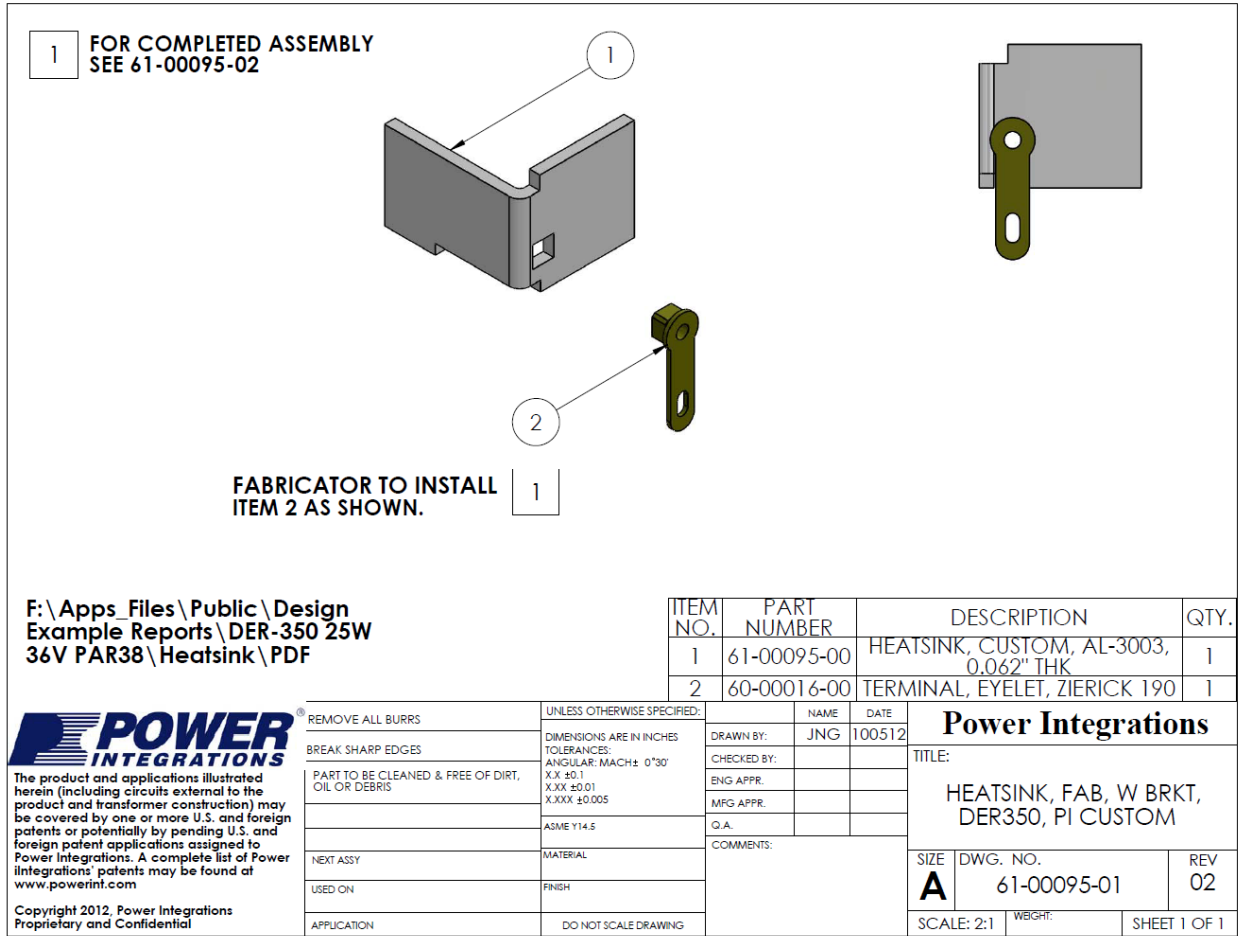

Figure 12 – U1 Heat Sink Assembly Drawing.



10.3 U1 and Heat Sink Assembly Drawing

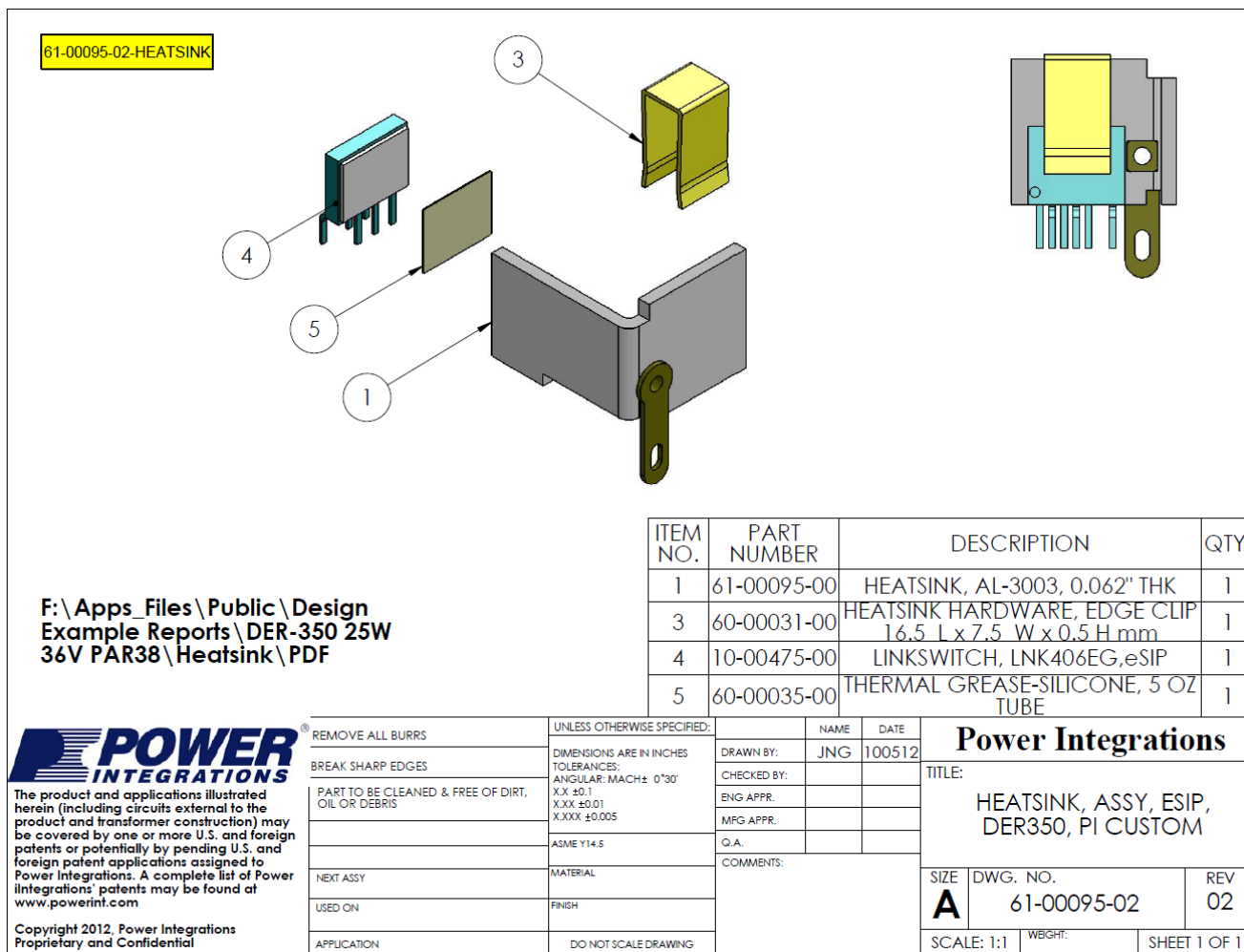

Figure 13 – U1 and Heat Sink Assembly Drawing.



11 Performance Data

All measurements performed at room temperature using an LED load. The table in Section 11.6 shows complete test data values.

11.1 Efficiency

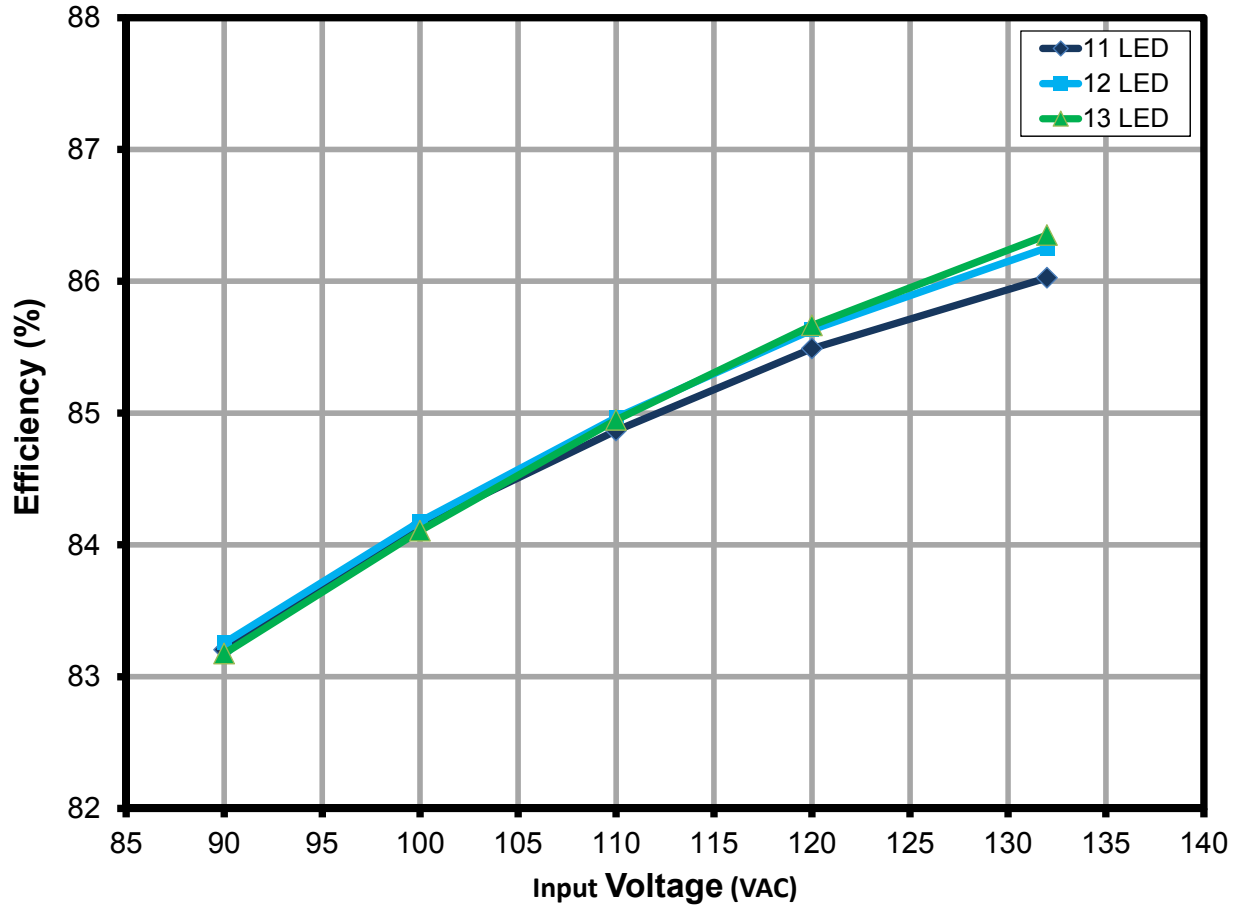

Figure 14 – Efficiency vs. Line.

11.2 Line and Load Regulation

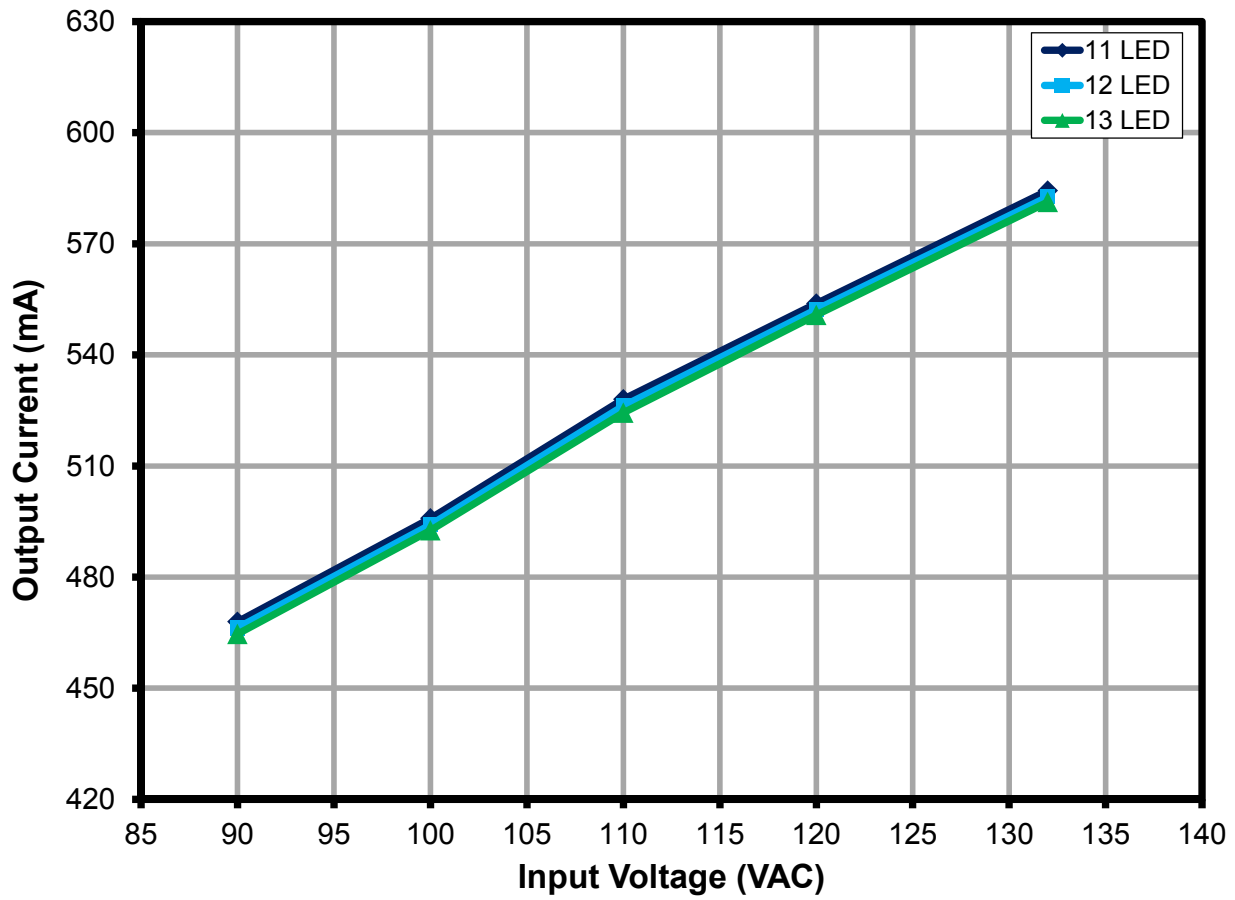

Figure 15 – Regulation vs. Line and Load.



11.3 Power Factor

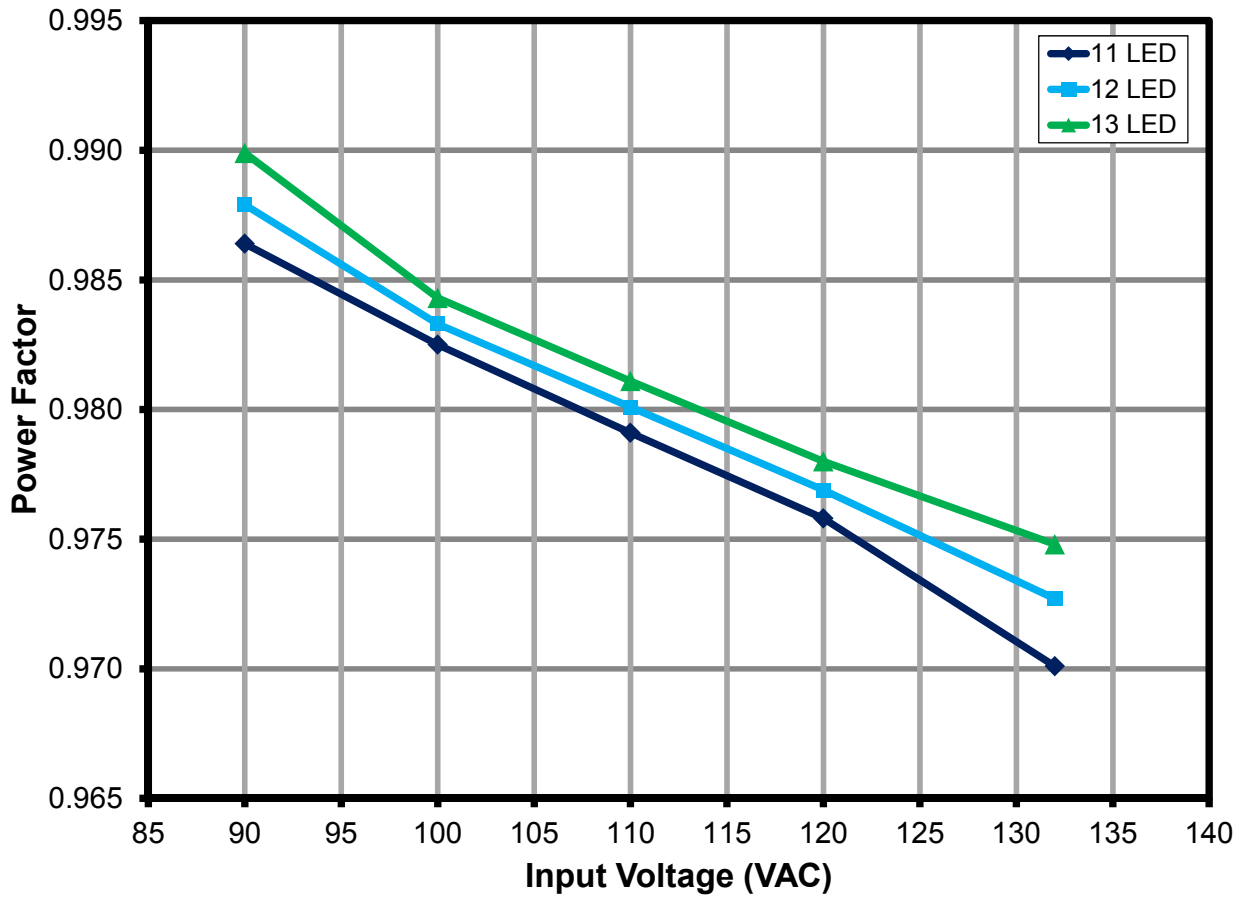

Figure 16 – Power Factor vs. Line and Load.



11.4 A-THD

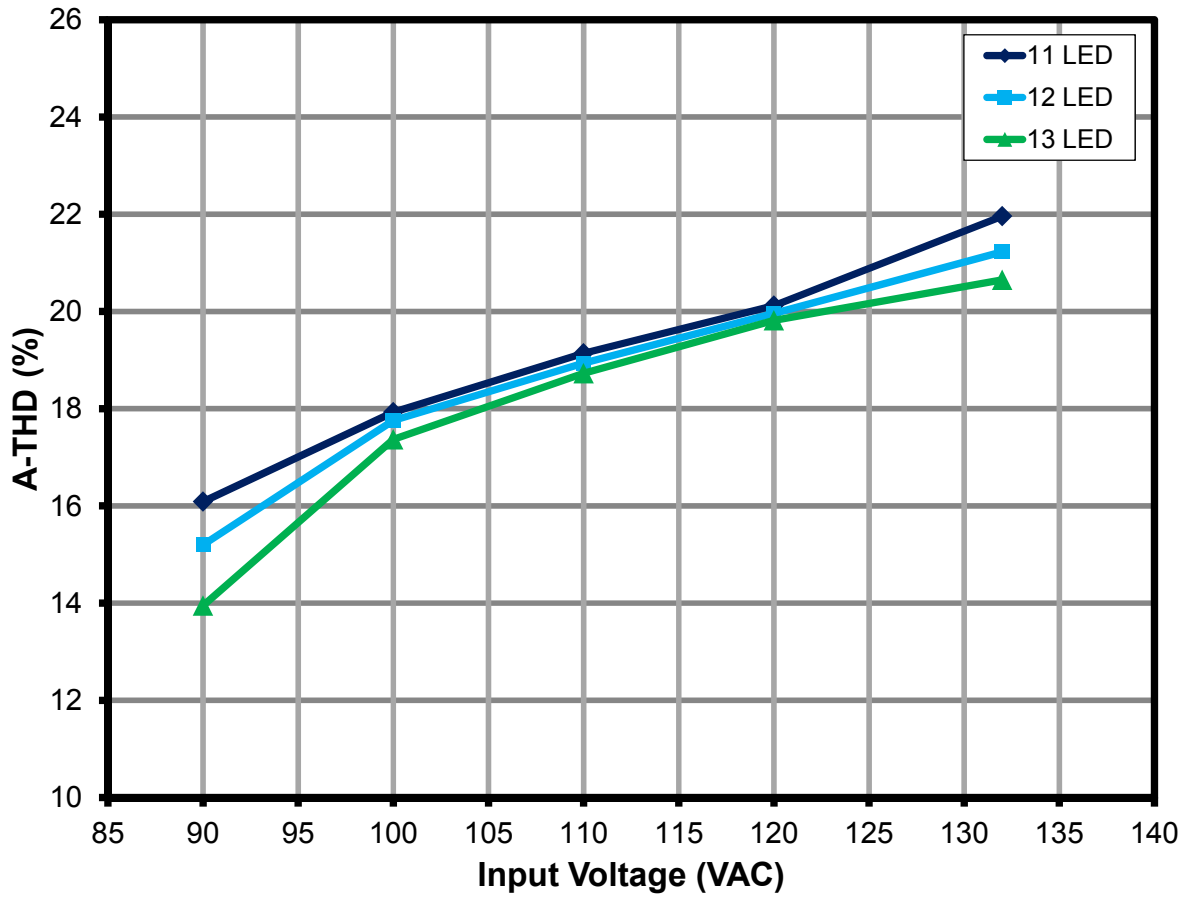

Figure 17 – A-THD vs. Line and Load.



11.5 Harmonic Currents

The design met the IEC61000-3-2 Limits for Class C equipment (section 7.3-a) for an Active input power of >25 W, which states that the harmonic currents shall not exceed the related limits given in Table 2 - Limits for Class C equipment.

11.5.1 11 LED Load

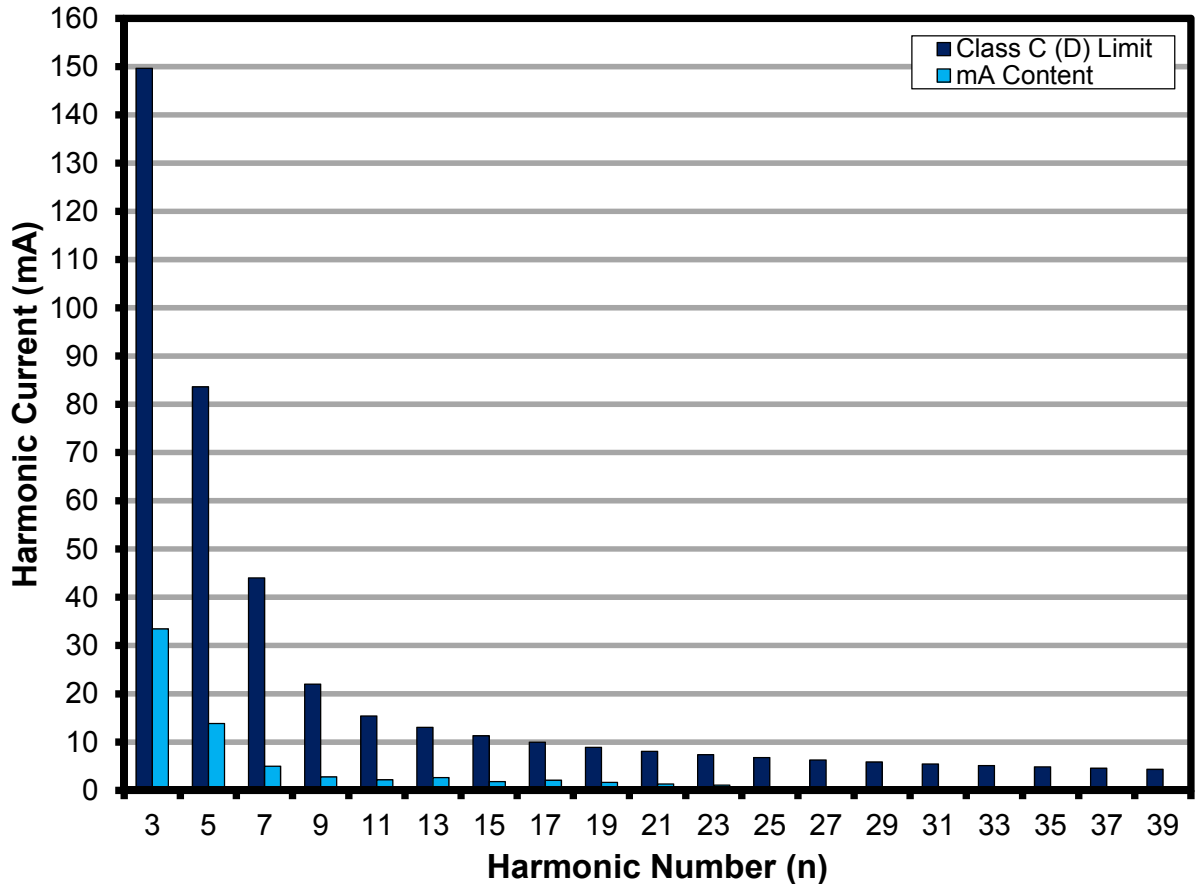

Figure 18 – 11 LED Load Input Current Harmonics (IEC61000-3-2) at 120 VAC, 60 Hz.



11.5.2 12 LED Load

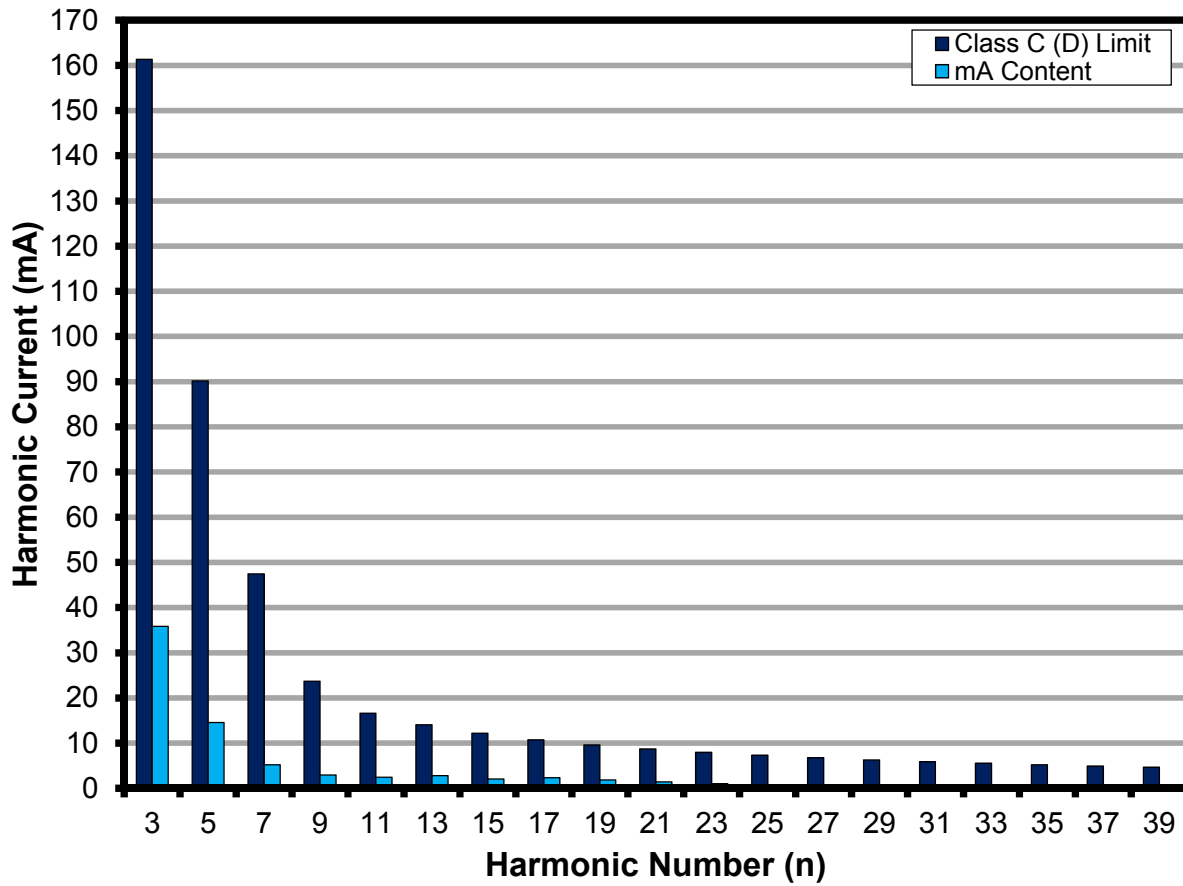

Figure 19 – 12 LED Load Input Current Harmonics case (IEC61000-3-2) at 120 VAC, 60 Hz.



11.5.3 13 LED Load

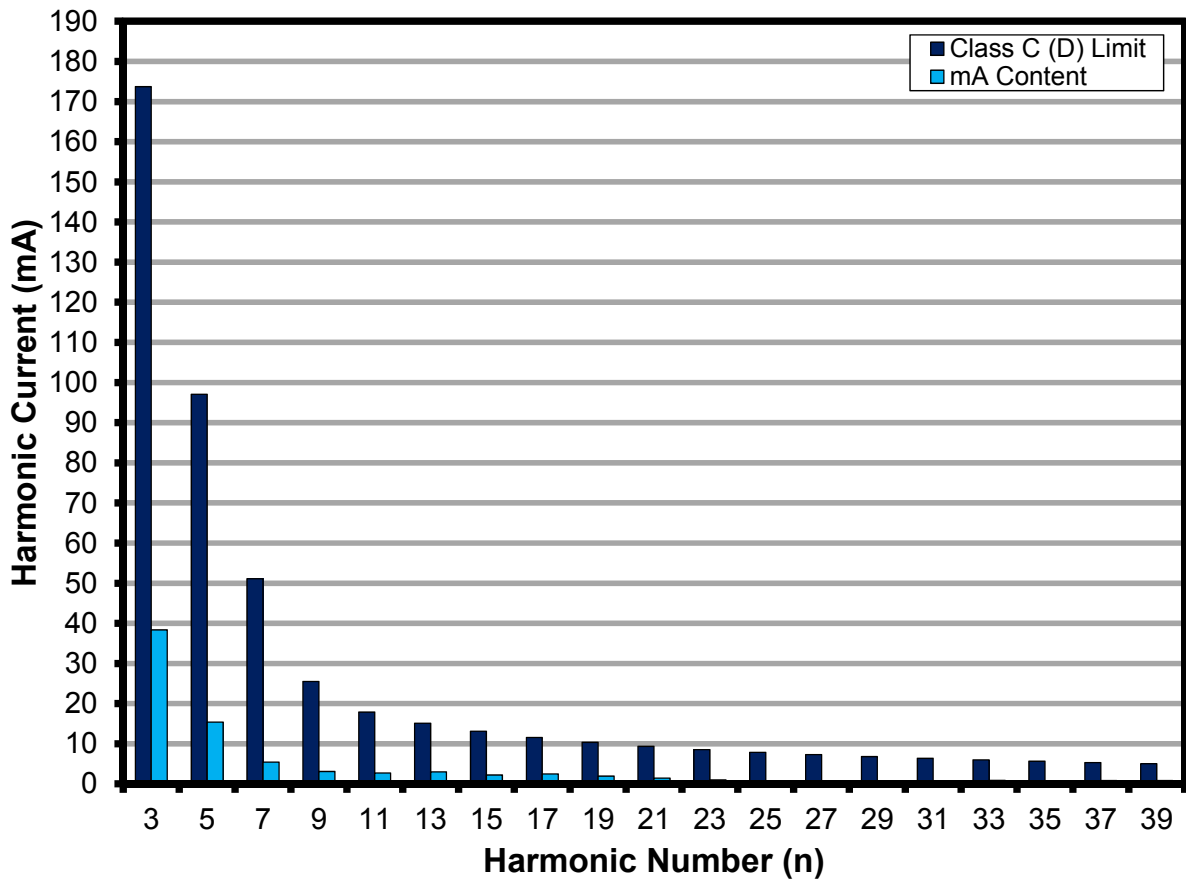

Figure 20 – 13 LED Load Input Current Harmonics (IEC61000-3-2) at 120 VAC, 60 Hz.



11.6 Test Data

All measurements were taken with the board at open frame, 25 °C ambient, and 60 Hz line frequency.

11.6.1 Test Data, 11 LED Load

Input Measurement					Load Measurement			Calculation		
V _{IN} (V _{RMS})	I _{IN} (mA _{RMS})	P _{IN} (W)	PF	%ATHD	V _{OUT} (V _{DC})	I _{OUT} (mA _{DC})	P _{OUT} (W)	P _{CAL} (W)	Efficiency (%)	Loss (W)
90.04	213.30	18.944	0.986	16.09	33.56	467.90	15.76	15.70	83.20	3.18
100.01	202.56	19.904	0.983	17.93	33.65	495.89	16.75	16.69	84.15	3.16
110.07	195.64	21.086	0.979	19.14	33.76	528.03	17.90	17.82	84.87	3.19
120.05	187.84	22.004	0.976	20.12	33.83	553.86	18.81	18.74	85.49	3.19
132.08	180.56	23.136	0.970	21.96	33.92	584.33	19.90	19.82	86.03	3.23

11.6.2 Test Data, 12 LED Load

Input Measurement					Load Measurement			Calculation		
V _{IN} (V _{RMS})	I _{IN} (mA _{RMS})	P _{IN} (W)	PF	%ATHD	V _{OUT} (V _{DC})	I _{OUT} (mA _{DC})	P _{OUT} (W)	P _{CAL} (W)	Efficiency (%)	Loss (W)
90.03	229.36	20.401	0.988	15.20	36.30	466.32	16.99	16.93	83.26	3.42
100.01	218.20	21.456	0.983	17.76	36.43	494.09	18.06	18.00	84.18	3.40
110.07	210.62	22.723	0.980	18.94	36.56	526.19	19.31	19.24	84.97	3.42
120.05	202.30	23.726	0.977	19.96	36.65	552.30	20.32	20.24	85.63	3.41
132.08	194.00	24.923	0.973	21.23	36.76	582.69	21.50	21.42	86.25	3.43

11.6.3 Test Data, 13 LED Load

Input Measurement					Load Measurement			Calculation		
V _{IN} (V _{RMS})	I _{IN} (mA _{RMS})	P _{IN} (W)	PF	%ATHD	V _{OUT} (V _{DC})	I _{OUT} (mA _{DC})	P _{OUT} (W)	P _{CAL} (W)	Efficiency (%)	Loss (W)
90.03	246.50	21.967	0.990	13.95	39.21	464.64	18.27	18.22	83.17	3.70
100.00	234.86	23.117	0.984	17.37	39.36	492.59	19.44	19.39	84.11	3.67
110.06	226.53	24.460	0.981	18.73	39.50	524.39	20.78	20.72	84.95	3.68
120.04	217.61	25.547	0.978	19.82	39.61	550.75	21.89	21.82	85.67	3.66
132.07	208.34	26.822	0.975	20.65	39.72	581.26	23.16	23.09	86.35	3.66



11.6.4 120 VAC 60 Hz, 11 LED Load Harmonics Data

Current Harmonics Limits for IEC61000-3-2

V	Freq	I (mA)	P	PF	%THD
120	60.00	187.84	22.0040	0.9758	20.12
nth Order	mA Content	% Content	Limit <25 W	Limit >25 W	Remarks
1	183.99				
2	0.04	0.02%		2.00%	
3	33.44	18.17%	149.6272	29.27%	Pass
5	13.81	7.51%	83.6152	10.00%	Pass
7	4.99	2.71%	44.0080	7.00%	Pass
9	2.76	1.50%	22.0040	5.00%	Pass
11	2.19	1.19%	15.4028	3.00%	Pass
13	2.63	1.43%	13.0331	3.00%	Pass
15	1.82	0.99%	11.2954	3.00%	Pass
17	2.08	1.13%	9.9665	3.00%	Pass
19	1.62	0.88%	8.9174	3.00%	Pass
21	1.30	0.71%	8.0681	3.00%	Pass
23	1.06	0.58%	7.3666	3.00%	Pass
25	0.28	0.15%	6.7772	3.00%	Pass
27	0.12	0.07%	6.2752	3.00%	Pass
29	0.54	0.29%	5.8424	3.00%	Pass
31	0.56	0.30%	5.4655	3.00%	Pass
33	0.67	0.36%	5.1343	3.00%	Pass
35	0.61	0.33%	4.8409	3.00%	Pass
37	0.28	0.15%	4.5792	3.00%	Pass
39	0.28	0.15%	4.3444	3.00%	Pass
41	0.34	0.18%			
43	0.33	0.18%			
45	0.40	0.22%			
47	0.34	0.18%			
49	0.19	0.10%			



11.6.5 120 VAC 60 Hz, 12 LED Load Harmonics Data

Current Harmonics Limits for IEC61000-3-2

V	Freq	I (mA)	P	PF	%THD
120	60.00	202.30	23.7260	0.9769	19.96
nth Order	mA Content	% Content	Limit <25 W	Limit >25 W	Remarks
1	198.22				
2	0.03	0.02%		2.00%	
3	35.84	18.08%	161.3368	29.31%	Pass
5	14.56	7.35%	90.1588	10.00%	Pass
7	5.20	2.62%	47.4520	7.00%	Pass
9	2.94	1.48%	23.7260	5.00%	Pass
11	2.44	1.23%	16.6082	3.00%	Pass
13	2.81	1.42%	14.0531	3.00%	Pass
15	2.06	1.04%	12.1793	3.00%	Pass
17	2.35	1.19%	10.7465	3.00%	Pass
19	1.86	0.94%	9.6153	3.00%	Pass
21	1.43	0.72%	8.6995	3.00%	Pass
23	1.03	0.52%	7.9431	3.00%	Pass
25	0.12	0.06%	7.3076	3.00%	Pass
27	0.14	0.07%	6.7663	3.00%	Pass
29	0.71	0.36%	6.2997	3.00%	Pass
31	0.62	0.31%	5.8932	3.00%	Pass
33	0.71	0.36%	5.5361	3.00%	Pass
35	0.62	0.31%	5.2197	3.00%	Pass
37	0.27	0.14%	4.9376	3.00%	Pass
39	0.28	0.14%	4.6844	3.00%	Pass
41	0.35	0.18%			
43	0.36	0.18%			
45	0.49	0.25%			
47	0.43	0.22%			
49	0.27	0.14%			



11.6.6 120 VAC 60 Hz, 13 LED Load Harmonics Data

Current Harmonics Limits for IEC61000-3-2

V	Freq	I (mA)	P	PF	%THD
120	60.00	217.61	25.5470	0.9780	19.82
nth Order	mA Content	% Content	Limit <25 W	Limit >25 W	Remarks
1	213.26				
2	0.05	0.02%		2.00%	
3	38.35	17.98%	173.7196	29.34%	Pass
5	15.40	7.22%	97.0786	10.00%	Pass
7	5.43	2.55%	51.0940	7.00%	Pass
9	3.09	1.45%	25.5470	5.00%	Pass
11	2.69	1.26%	17.8829	3.00%	Pass
13	3.00	1.41%	15.1317	3.00%	Pass
15	2.20	1.03%	13.1141	3.00%	Pass
17	2.49	1.17%	11.5713	3.00%	Pass
19	1.93	0.90%	10.3533	3.00%	Pass
21	1.45	0.68%	9.3672	3.00%	Pass
23	1.02	0.48%	8.5527	3.00%	Pass
25	0.19	0.09%	7.8685	3.00%	Pass
27	0.19	0.09%	7.2856	3.00%	Pass
29	0.78	0.37%	6.7832	3.00%	Pass
31	0.73	0.34%	6.3455	3.00%	Pass
33	0.86	0.40%	5.9610	3.00%	Pass
35	0.55	0.26%	5.6203	3.00%	Pass
37	0.83	0.39%	5.3165	3.00%	Pass
39	0.85	0.40%	5.0439	3.00%	Pass
41	0.52	0.24%			
43	0.61	0.29%			
45	0.68	0.32%			
47	0.68	0.32%			
49	0.42	0.20%			



12 Dimming Performance Data

TRIAC dimming results were taken at an input voltage of 120 VAC, 60 Hz line frequency, room temperature, and a nominal 36 V LED load.

The output current High Limit I_{OUT} (Max) and Low Limit I_{OUT} (Min) were incorporated based on the USA NEMA publication SSL6-2010 section 4 page 9 for dimming performance system requirements for reference. The standard however refers to 120 VAC operating input voltage and pertains to the limits as relative light output. The limits incorporated on the succeeding graphs assumes that 100% relative light output falls on the maximum operating output current of 550 mA and 0 mA as 0% light output, and input line of 120 VAC, 60 Hz.

12.1 Dimming Curve with Simulated (Using Agilent 6812B AC Source) Leading Edge Dimmer

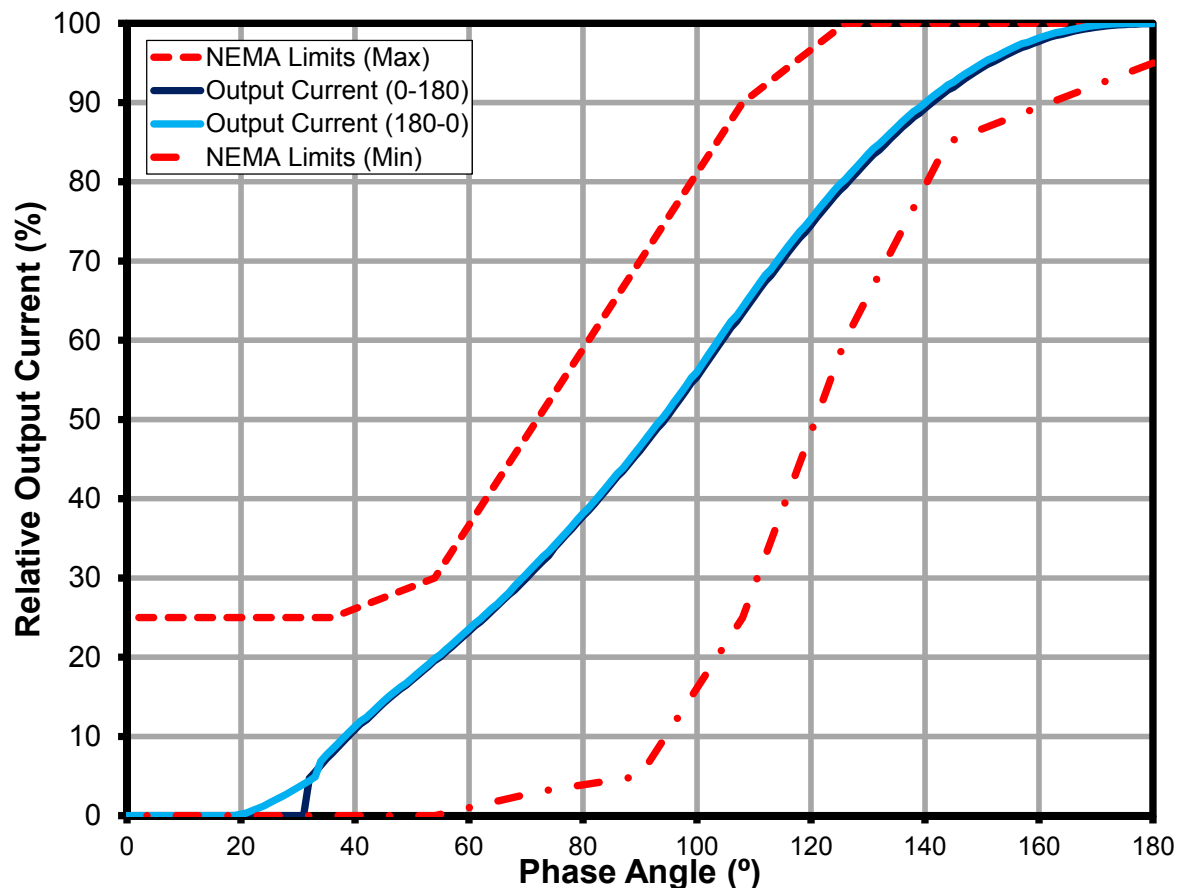

Figure 21 – Dimming Curve at 120 VAC, 60 Hz Input.



12.2 Fast Start-up (<200 ms) with TRIAC-Based Dimmer

Using a TRIAC-based U.S. dimmer model S-600P-WH (Lutron) with thumb-wheel adjust set to minimum turn-on (i.e. <30 degrees) which guarantees the LED driver is off when it is switched to ON position. The test was made by turning/sliding the dimmer knob as quickly as possible from minimum to maximum position then measuring the time from the point the dimmer started conducting to the point the output current started rising.

Input voltage: 120 VAC / 60 Hz

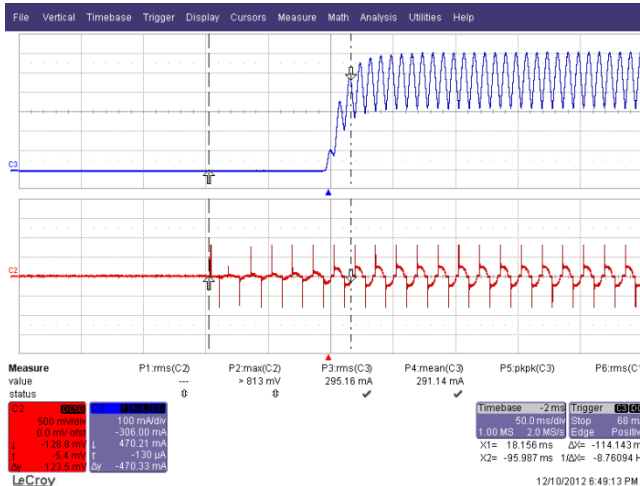

Figure 22 – Measured Start-up Time 114 ms.
 Flicking the Switch ON, Dimmer at Full Conduction.
 Upper: I_{OUT} , 100 mA / div.
 Lower: I_{IN} , 500 mA, 50 ms / div.

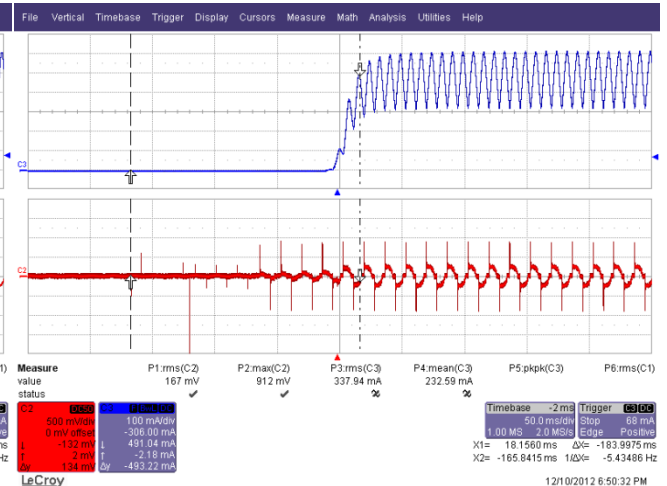

Figure 23 – Measured Start-up Time 184 ms.
 Quickly Sliding the Knob from Minimum to Full Conduction.
 Upper: I_{OUT} , 100 mA / div.
 Lower: I_{IN} , 500 mA, 50 ms / div.



12.3 Pop-on Point with TRIAC-based Dimmer

Pop-on per NEMA SSL-6 definition is lowest dimmer setting above minimum at which the lamp transitions from off to dimmed.

This particular test was conducted using 120 V / 60 Hz TRIAC dimmer model S-600P-WH (Lutron U.S. dimmer).

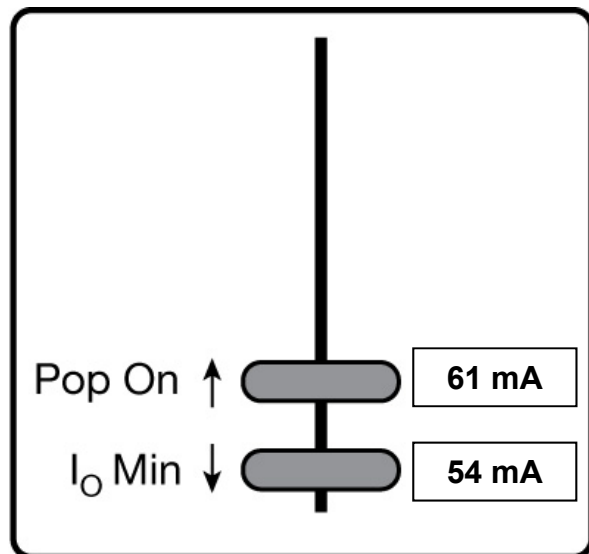

Figure 24 – 35° Conduction Angle was Measured at Pop-on Point.

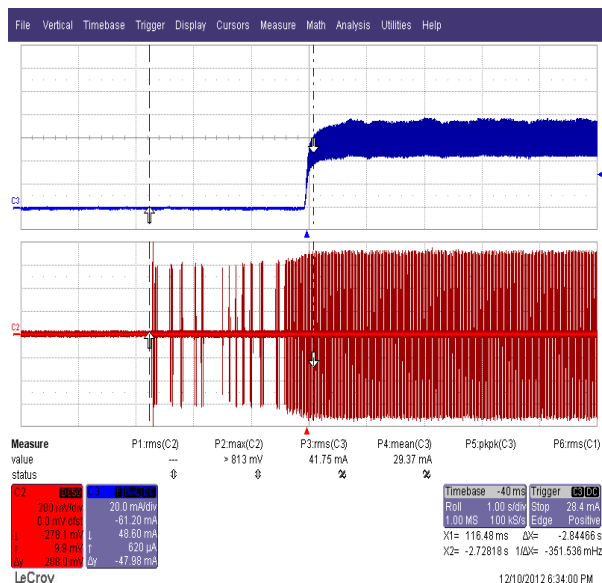

Figure 25 – 35° Conduction Angle at Pop-on Point.
 Upper: I_{OUT} , 20 mA / div.
 Middle: V_{OUT} , 200 V / div.
 Lower: I_{IN} , 0.2 A / div., 1 s / div.



12.4 Output Current and Input Current Waveforms with Dimmer

Input: 120 VAC, 60 Hz Utility Line

Output: 36 V LED Load

Dimmer: LUTRON GL-600WH

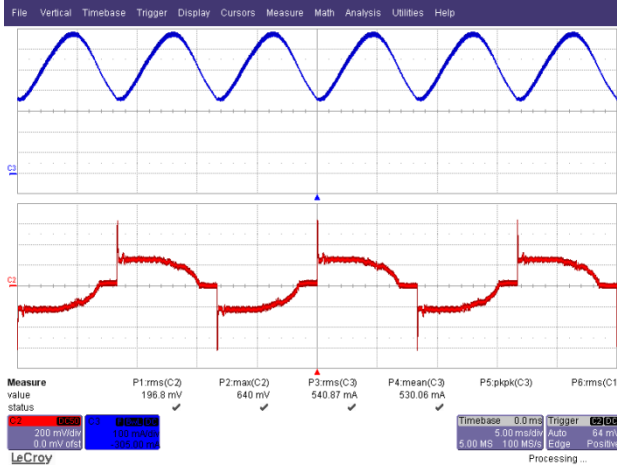

Figure 26 – 147° Conduction Angle.
 Upper: I_{OUT} , 100 mA / div.
 Lower: I_{IN} , 200 mA, 5 ms / div.

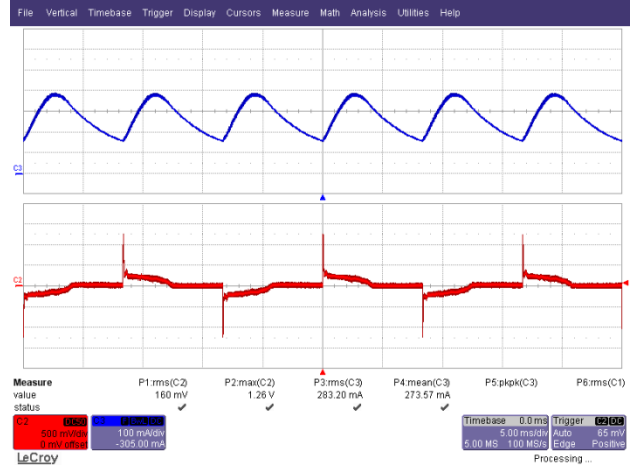

Figure 27 – 90° Conduction Angle.
 Upper: I_{OUT} , 100 mA / div.
 Lower: I_{IN} , 500 mA, 5 ms / div.

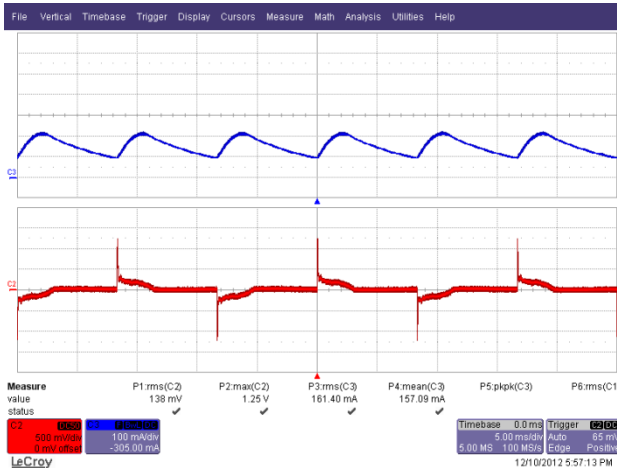

Figure 28 – 60° Conduction Angle.
 Upper: I_{OUT} , 100 mA / div.
 Lower: I_{IN} , 500 mA, 5 ms / div.

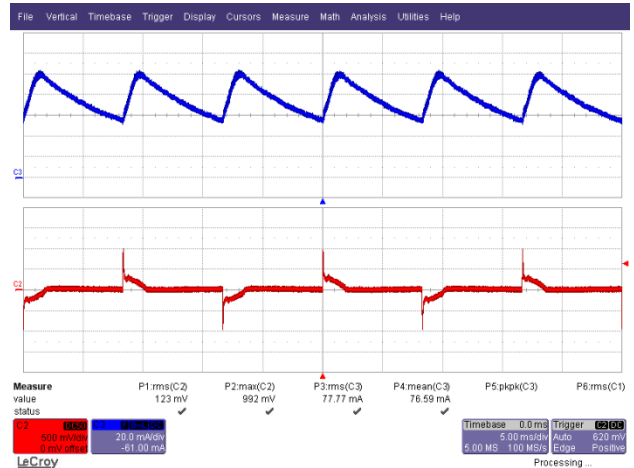

Figure 29 – 40° Conduction Angle.
 Upper: I_{OUT} , 20 mA / div.
 Lower: I_{IN} , 500 mA, 5 ms / div.



12.6 Compatibility List

The following U.S. TRIAC-based dimmers were tested with utility line input (~120 VAC, 60 Hz) and 36 V LED load.

Dimmer Brand	Type	Part Number	V _{RMS(MIN)}	I _{MIN} (mA)	V _{RMS(MAX)}	I _{MAX} (mA)	Dim Ratio
Lutron	L	LG-600PH-WH	24	41	115.5	492	12
Lutron	L	S-603P-WH	24.5	43	116.0	497	12
Lutron	L	SLV600P-WH	29	62	116.7	505	8
Lutron	L	S-600-WH	27.5	57	118.5	530	9
Lutron	L	S-600PH-WH	23	40	116.1	501	13
Lutron	L	DVWCL-153-PLH-WH	21.8	32	114.0	484	15
Lutron	L	DV-603P-WH	25	48	115.6	498	10
Lutron	L	DV-600P-WH	24	42	115.8	498	12
Lutron	L	TG-600PH-WH	40	87	117.0	513	6
Lutron	L	Q-600P-WH aka FA-600	19.6	18	115.0	494	28
Lutron	L	AY-600P-WH	42.2	91	116.5	508	6
Lutron	L	GL-600P-WH	28.5	61	116.0	502	8
Leviton	L	R62-06633-1LW	24	42	119.8	549	13
Leviton	L	R62-06631-1LW	13	4	117.6	520	130
Leviton	L	R60-IPI06-1LM	43	95	119.2	542	6
Leviton	E	R52-06161-00W	33	60	116.3	507	8
Leviton	L	R52-RPI06-1LW	32	50	119.9	555	11
Leviton	L	TGM10-1LW	16.8	12	115.0	493	41
Leviton	L	R02-06613-PLW	21	28	120.0	550	20
Cooper	L	SLC03P-W-K-L	16	10	117.4	519	51
Lutron	L	GL-600-WH	31	66	118.4	533	8
Lutron	L	DVPDC-203P-WH	65	166	118.0	527	3
Lutron	L	LX-600PL-wh	29	60	118.0	525	9
Lutron	L	CTCL-153PDH	20	21	114.7	488	23
Lutron	L	S-600P	22	36	116.0	503	14
Lutron	L	TGLV-600P	33	70	117.0	517	7
Lutron	L	TGLV-600PR	32	67	117.0	512	8
Lutron	L	TT-300NLH-WH	40	84	119.0	540	6
Lutron	L	NLV-1000-WH	25	45	117.4	519	12
Lutron	T		30.7	52	115.5	495	10
Lutron	L		24	41	118.2	532	13
Cooper	L		32	70	118.0	528	8
Lutron	L	S-103P-WH	32	68	116.0	503	7
Lutron	L	S-10P-WH	27	56	115.0	496	9
Lutron	L	S-600PNLH-WH	29	63	116.2	511	8
Lutron	L	S-603PNL-WH	31	68	116.0	508	7
Lutron	L	SLV-603P-WH	33	71	116.0	506	7
Lutron	L	AYLV-600P-WH	33	71	117.0	514	7
Lutron	L	AYLV-603P-WH	33.5	73	115.0	497	7
Lutron	L	AY-103PNL-WH	31	65	117.6	523	8
Lutron	L	AY-103P-WH	31	60	118.0	526	9
Lutron	L	AY-10PNL-WH	29	63	119.8	551	9



Lutron	L	AY-10P-WH	24.5	44	117.8	528	12
Lutron	L	AY-603PNL-WH	34	73	114.6	493	7
Lutron	L	AY-603PG-WH	37	77	103.7	395	5
Lutron	L	AY-603P-WH	41	90	115.1	497	6
Lutron	L	AY-600PNL-WH	37	76	116.6	512	7
Lutron	T	DVELV-300P-WH	25	33	112.3	458	14
Lutron	L	DVLV-10P-WH	34	72	115.8	493	7
Lutron	L	DVLV-103P-WH	33	70	115.9	498	7
Lutron	L	DVLV-603P-WH	32	68	116.0	500	7
Lutron	L	S-1000-WH	32	67	118.6	531	8
Lutron	T	SELV-300P-WH	25	34	111.0	452	13
Lutron	L	S-600P-WH	24	41	115.6	501	12
Lutron	L	S-103PNL-WH	33.5	66	115.3	498	8
Lutron		SPSLV-1000-WH	30	64	117.0	518	8
Lutron		SPSLV-600-WH	30	64	116.7	517	8
Lutron		SPSELV-600-WH	30	52	115.7	496	10
Lutron	L	GLV-600-WH	24	43	118.5	533	12
Lutron	L	LG-603PGH-WH	27	54.0	106.0	408.0	8
Lutron	L	DVW-603PGH-WH	29	61.0	106.1	409.0	7
Leviton	L	VPI06	26	51.0	116.9	510.0	10
Lutron	L	TG-10PR-WH	39.7	85.0	118.0	523.0	6
Lutron	L	NT-600	22.5	32.0	118.7	532.0	17
Lutron	L	NT-1000	23	38.0	118.7	534.0	14
Lutron	L	LGCL-153PLH-WH	27	56.0	114.2	486.0	9
Lutron	L	CTCL-153PDH-WH	37	75.0	115.0	491.0	7
Lutron	L	TGCL-153PH-WH	27	56.0	114.5	491.0	9
Lutron	L	DVWCL-153PH-LA	38.7	81.0	114.7	492.0	6
Leviton	L	81000-W	38	79.0	119.3	538.0	7
Lutron	L	TTCL-100LH-WH	37	76.0	114.4	486.0	6

Figure 30 – U.S. TRIAC-Based Dimmers Compatibility List.



13 Thermal Performance

13.1 Thermal Measurement with PAR38 Lamp

The UUT was placed inside a PAR38 with MT-G2 lamp provided by CREE and the lamp was screwed into a conical metal housing oriented in upside down position for worse case position. Type-T thermo-couple wire was attached on the body of each device under test. Temperature readings were recorded when it stabilizes after running more than one hour with 36 V LED (MT-G2) load at the specified input voltage and load current. The probe location for the ambient was shown on the figure below.

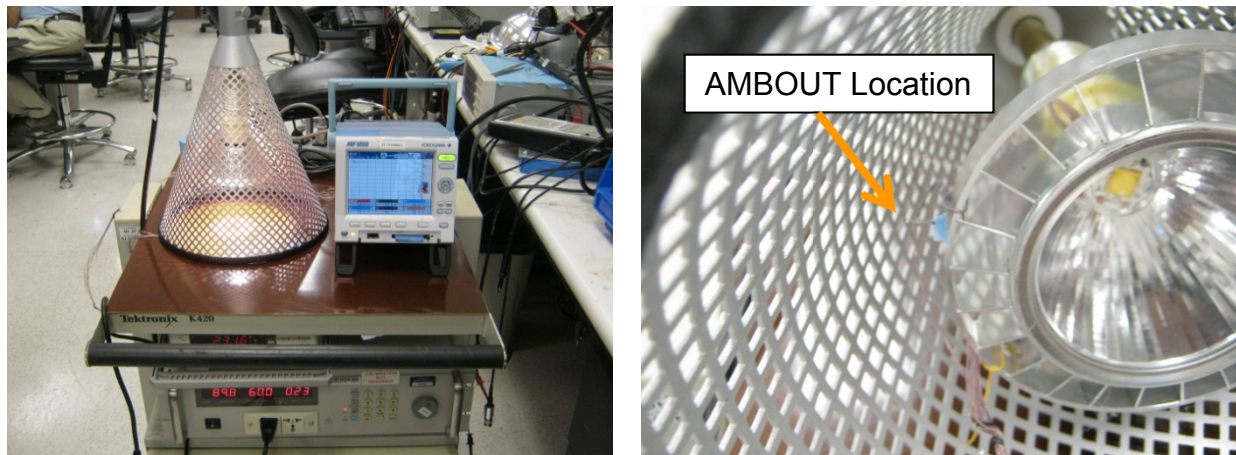

Figure 31 – Thermal Set-up.

13.2 90 VAC, Non-Dimming

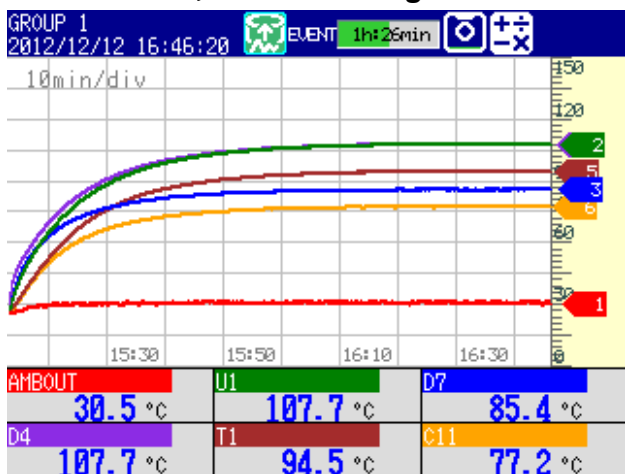

Figure 32 – 90 VAC.
AMBOU, U1, D7, D4, T1, C11.

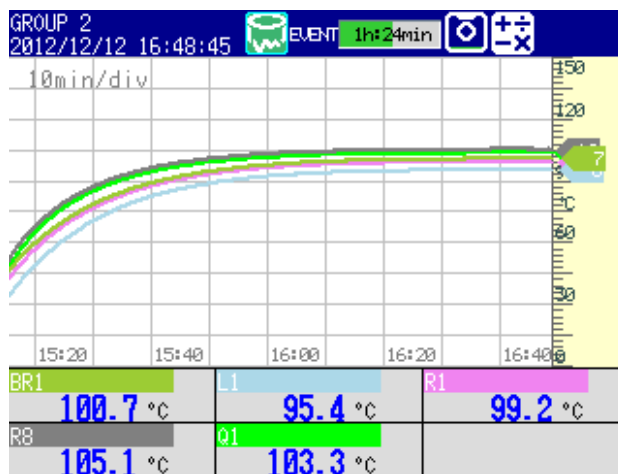

Figure 33 – 90 VAC Conduction Angle.
BR1, L1, R1, R8, Q1.



13.3 132 VAC, Non-Dimming

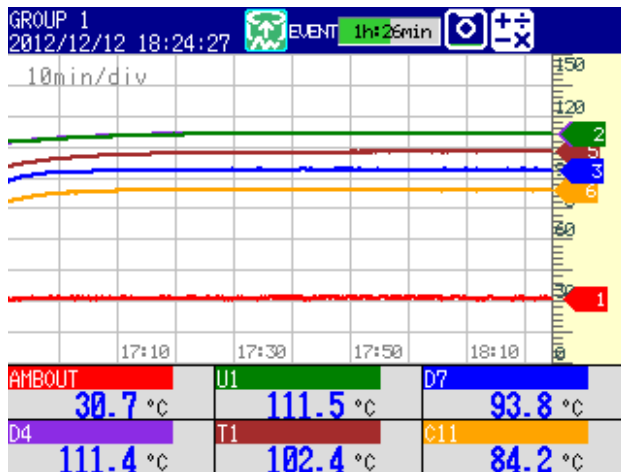

Figure 34 – 132 VAC.
AMBOU, U1, D7, D4, T1, C11.

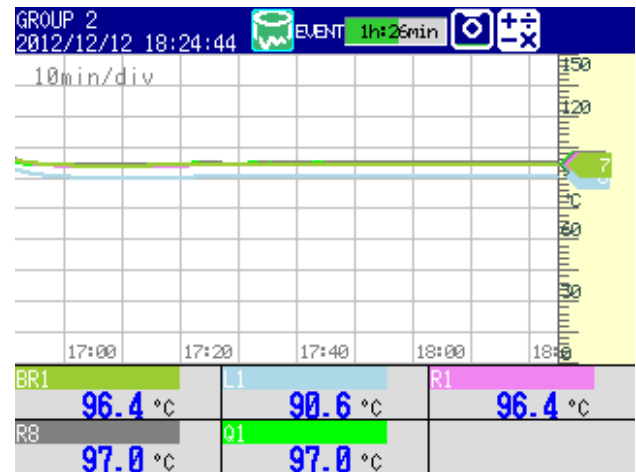

Figure 35 – 132 VAC.
BR1, L1, R1, R8, Q1.

13.4 120 VAC, 90° Conduction Angle

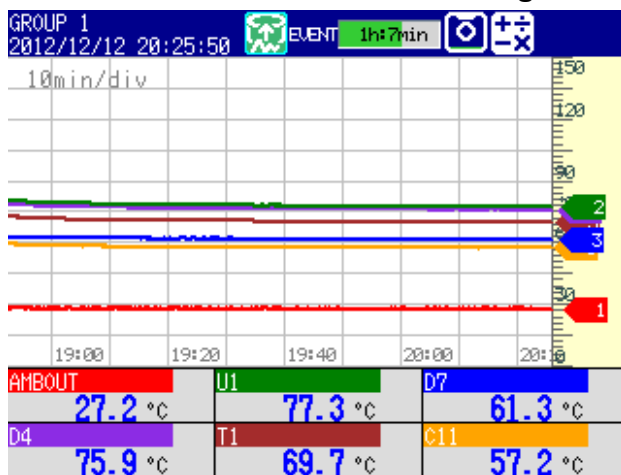

Figure 36 – 120 VAC, 90° Conduction Angle.
AMBOU, U1, D7, D4, T1, C11.

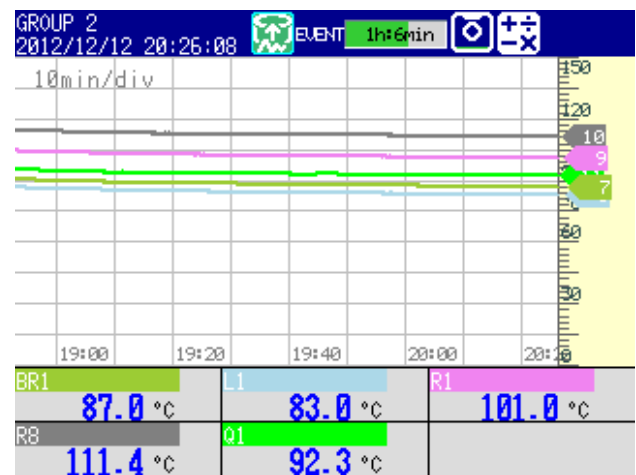

Figure 37 – 120 VAC, 90° Conduction Angle.
BR1, L1, R1, R8, Q1.



14 Non-Dimming Waveforms

14.1 Output Current and Input Current Waveforms

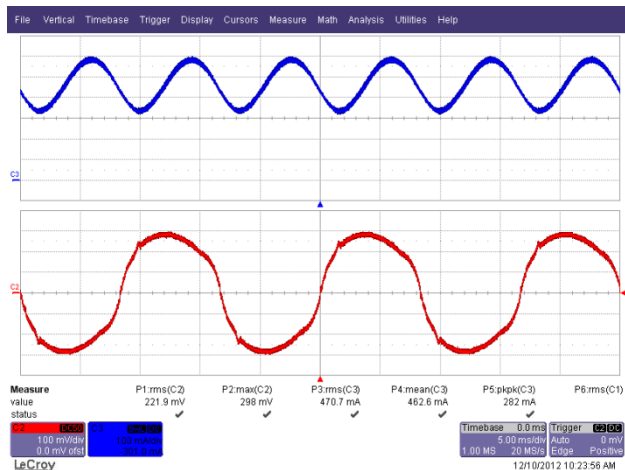

Figure 38 – 90 VAC, 36 V LED Load.
 Upper: I_{OUT} , 100 mA / div.
 Lower: I_{IN} , 100 mA, 5 ms / div.

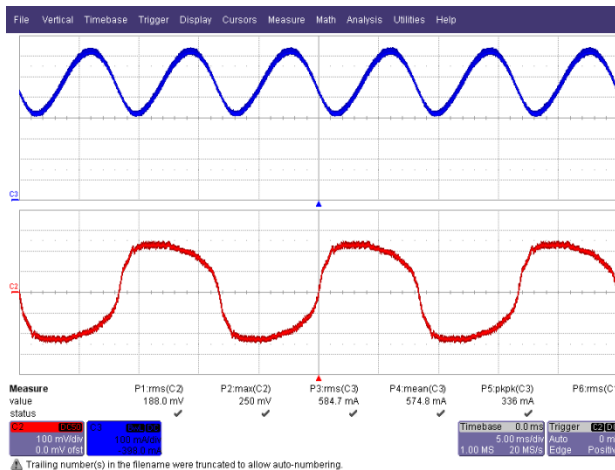

Figure 39 – 132 VAC, 36 V LED Load.
 Upper: I_{OUT} , 100 mA / div.
 Lower: I_{IN} , 100 mA, 5 ms / div.



14.2 Output Current and Output Voltage Waveform at Normal Operation

Input Condition	I _{OUT} , Mean (mA)	I _{OUT} , Peak to Peak (mA)	I _{OUT} Ripple (%)
90 VAC, 60 Hz	457	256	±28
120 VAC, 60 Hz	540	291	±27
132 VAC, 60 Hz	572	315	±28

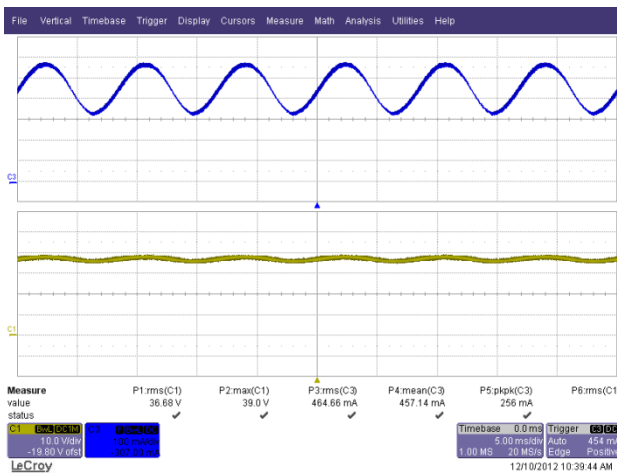

Figure 40 – 90 VAC, 60 Hz Full Load.
 Upper: I_{OUT}, 100 mA / div.
 Lower: V_{OUT}, 10 V, 5 ms / div.

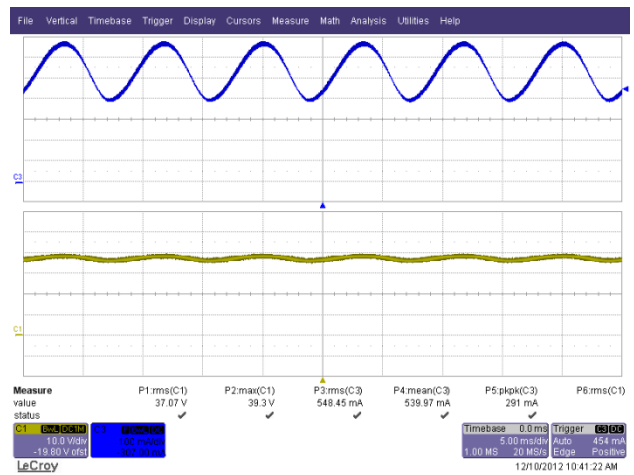

Figure 41 – 120 VAC, 60 Hz Full Load.
 Upper: I_{OUT}, 100 mA / div.
 Lower: V_{OUT}, 10 V, 5 ms / div.

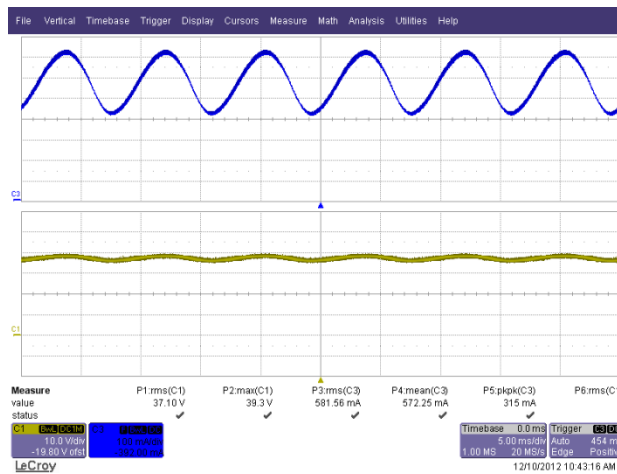

Figure 42 – 132 VAC, 60 Hz Full Load.
 Upper: I_{OUT}, 100 mA / div.
 Lower: V_{OUT}, 10 V, 5 ms / div.



14.3 Input Voltage and Output Current Waveform at Start-up

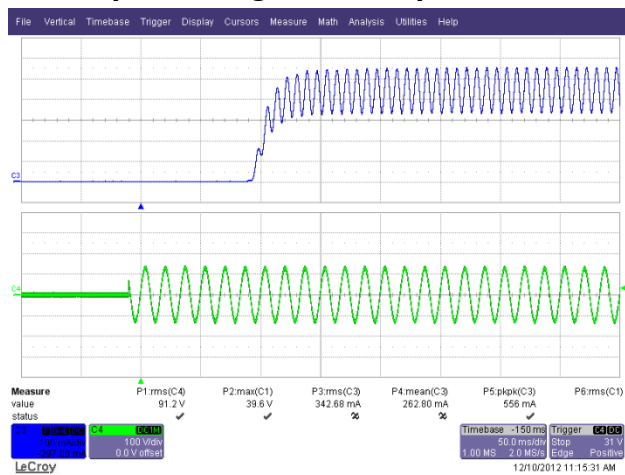

Figure 43 – 90 VAC, 60 Hz.
 Upper: I_{OUT} , 100 mA / div.
 Lower: V_{OUT} , 100 V, 50 ms / div.

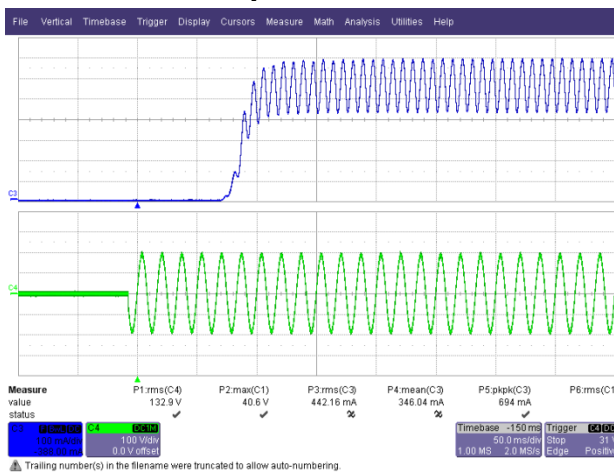

Figure 44 – 132 VAC, 60 Hz.
 Upper: I_{OUT} , 100 mA / div.
 Lower: V_{OUT} , 100 V, 50 ms / div.

14.4 Output Voltage and Output Current Waveform at Start-up

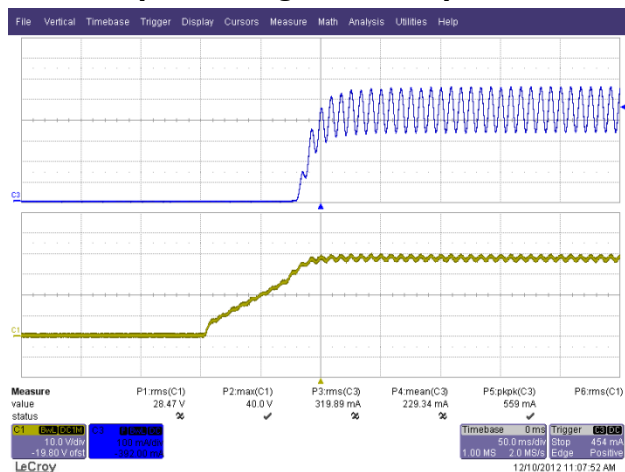

Figure 45 – 90 VAC, 60 Hz.
 Upper: I_{OUT} , 100 mA / div.
 Lower: V_{OUT} , 10 V, 50 ms / div.

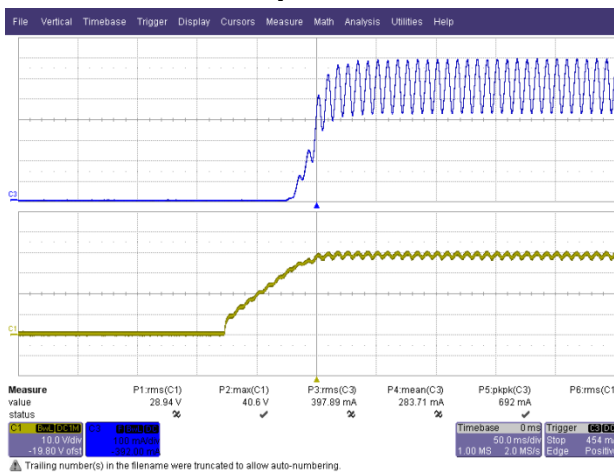

Figure 46 – 132 VAC, 60 Hz.
 Upper: I_{OUT} , 100 mA / div.
 Lower: V_{OUT} , 10 V, 50 ms / div.



14.5 Drain Voltage and Current at Normal Operation

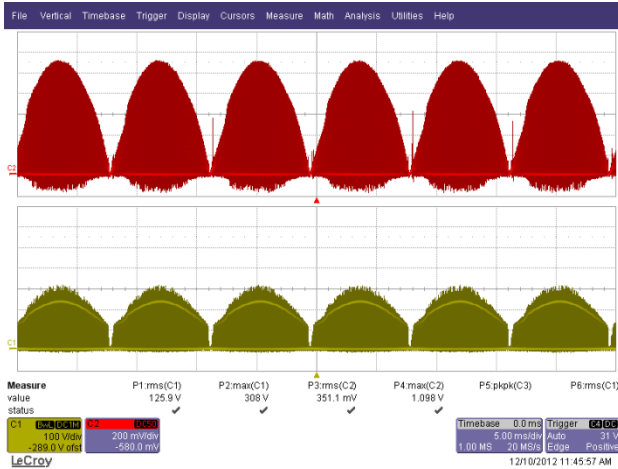

Figure 47 – 90 VAC, 60 Hz.
 Upper: I_{DRAIN} , 0.2 A / div.
 Lower: V_{DRAIN} , 100 V, 5 ms / div.

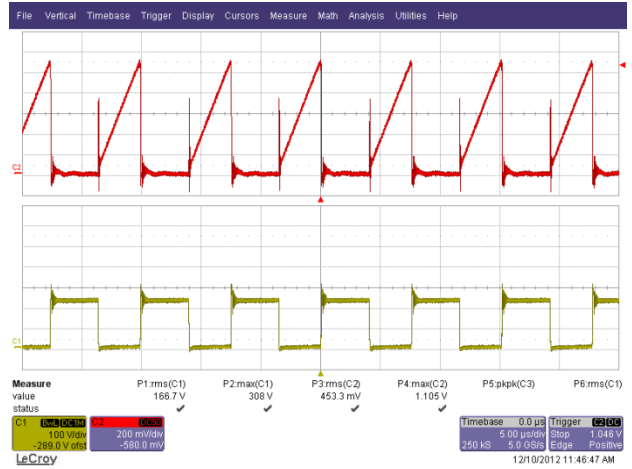

Figure 48 – 90 VAC, 60 Hz.
 Upper: I_{DRAIN} , 0.2 A / div.
 Lower: V_{DRAIN} , 100 V / div., 5 μs / div.

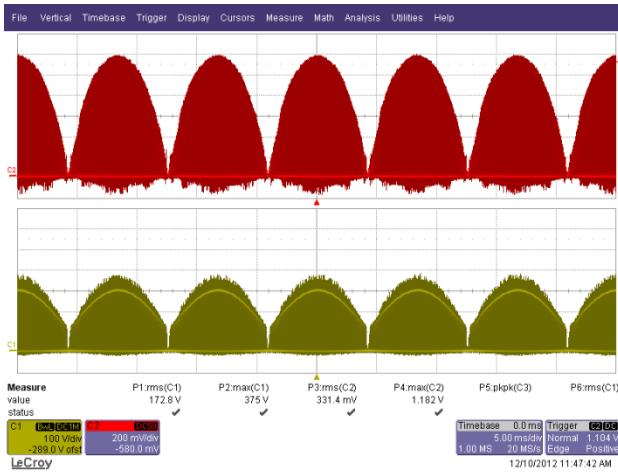

Figure 49 – 132 VAC, 60 Hz.
 Upper: I_{DRAIN} , 0.2 A / div.
 Lower: V_{DRAIN} , 100 V, 5 ms / div.

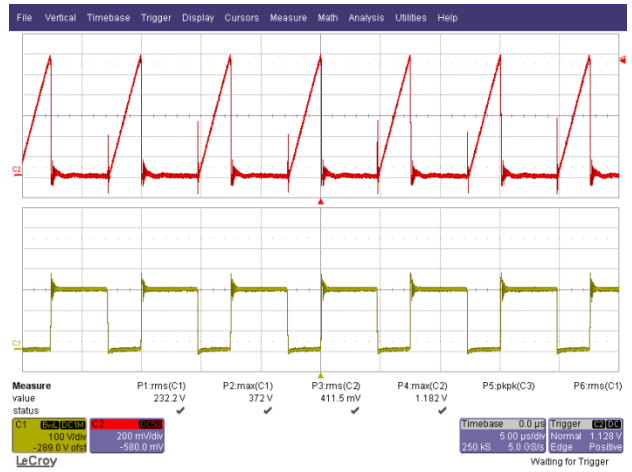

Figure 50 – 132 VAC, 60 Hz.
 Upper: I_{DRAIN} , 0.2 A / div.
 Lower: V_{DRAIN} , 100 V / div., 5 μs / div.



14.6 Drain Voltage and Current at Start-up

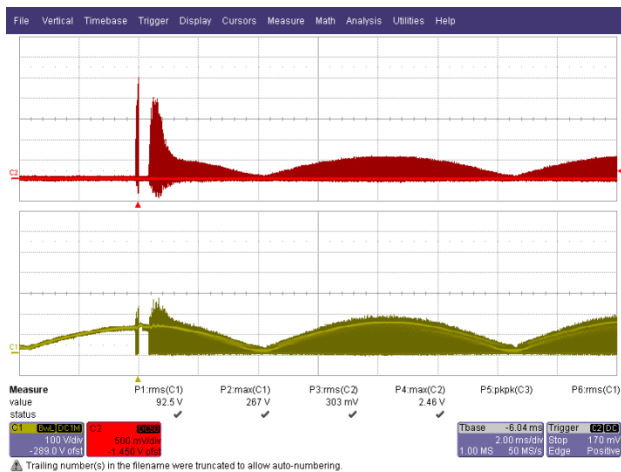

Figure 51 – 90 VAC, 60 Hz Start-up.
Upper: I_{DRAIN} , 500 mA / div.
Lower: V_{DRAIN} , 100 V, 2 ms / div.

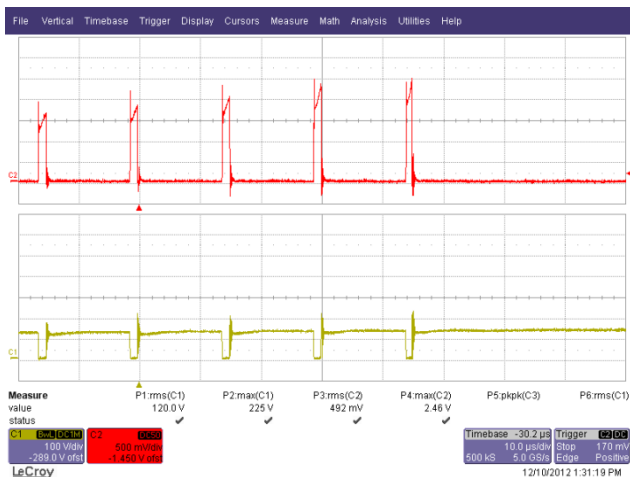

Figure 52 – 90 VAC, 60 Hz Start-up.
Upper: I_{DRAIN} , 500 mA / div.
Lower: V_{DRAIN} , 100 V, 10 μ s / div.

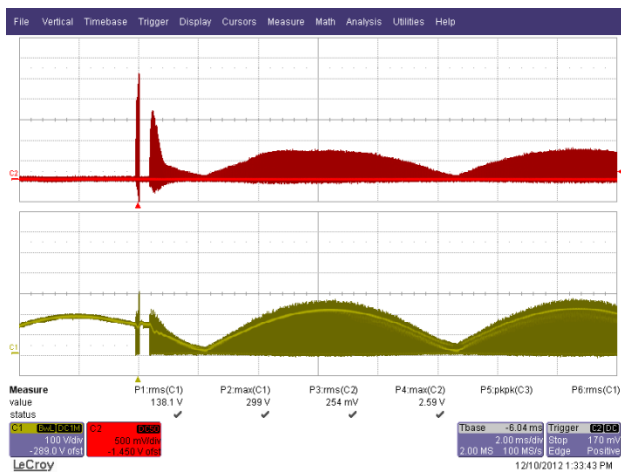

Figure 53 – 132 VAC, 60 Hz Start-up.
Upper: I_{DRAIN} , 500 mA / div.
Lower: V_{DRAIN} , 100 V, 2 ms / div.



Figure 54 – 132 VAC, 60 Hz Start-up.
Upper: I_{DRAIN} , 500 mA / div.
Lower: V_{DRAIN} , 100 V, 10 μ s / div.



14.7 Drain Voltage and Current at Output Short Condition

During output short condition, the I_{FB} current falls below the $I_{FB(AR)}$ threshold and enters the auto-restart condition. During this condition, to minimize power dissipation on the power components, the auto-restart circuit turns the power supply on and off at an auto-restart duty cycle of typically DC_{AR} for as long as the fault condition persists.

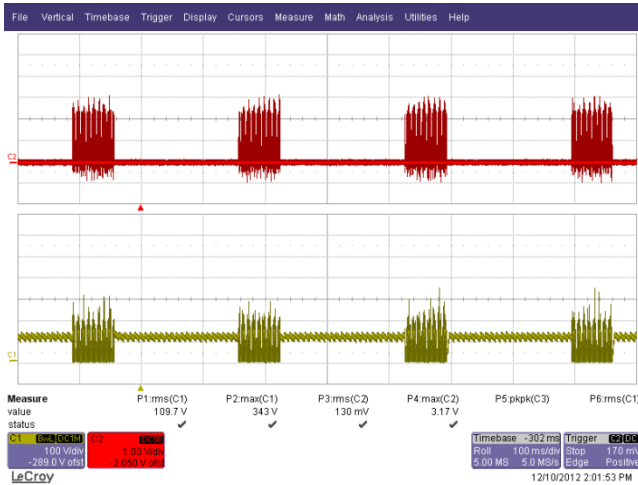

Figure 55 – 90 VAC, 60 Hz Output Short Condition.
 Upper: I_{DRAIN} , 1 A / div.
 Lower: V_{DRAIN} , 100 V, 100 ms / div.

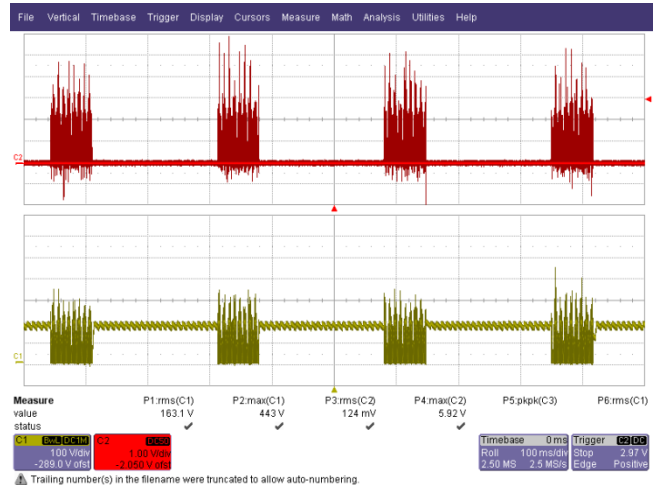

Figure 56 – 132 VAC, 60 Hz Output Short Condition.
 Upper: I_{DRAIN} , 1 A / div.
 Lower: V_{DRAIN} , 100 V, 100 ms / div.



14.8 Open Load Condition

The LED load was disconnected from the driver.

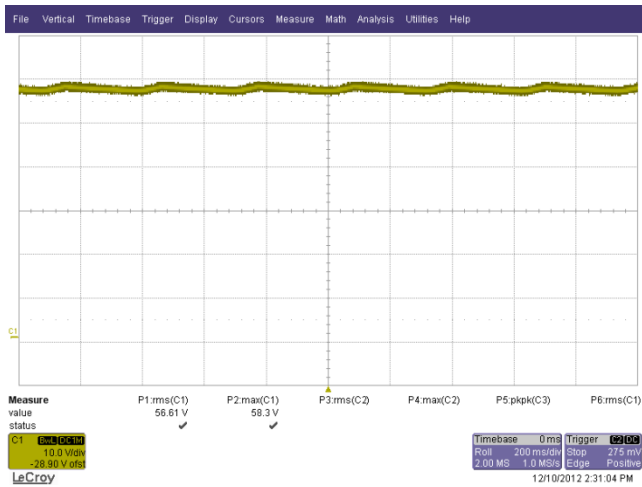

Figure 57 – 90 VAC, 60 Hz Output Open Load.
 CH4: V_{OUT} , 10 V, 200 ms / div.

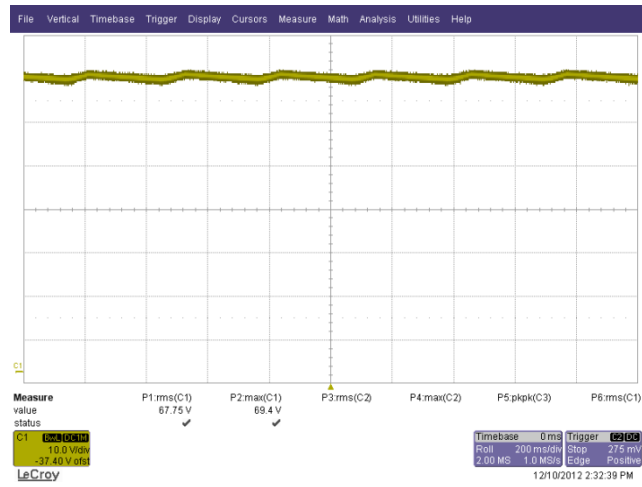

Figure 58 – 132 VAC, 60 Hz Output Open Load.
 CH4: V_{OUT} , 10 V, 200 ms / div.



14.9 Output Diode Voltage and Current Waveform at Normal Operation

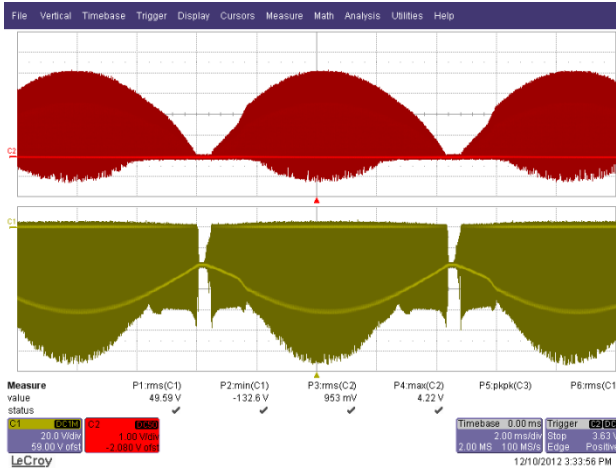

Figure 59 – 90 VAC, 60 Hz.
Upper: I_{D7} , 1 A / div.
Lower: V_{D7} , 10 V, 2 ms / div.

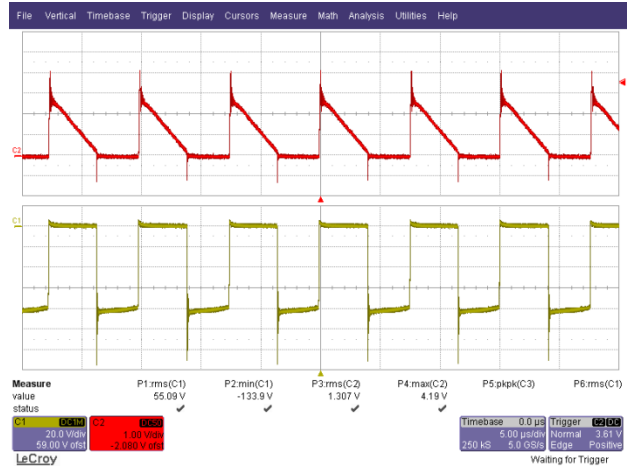

Figure 60 – 90 VAC, 60 Hz.
Upper: I_{D7} , 1 A / div.
Lower: V_{D7} , 20 V / div., 5 μ s / div.

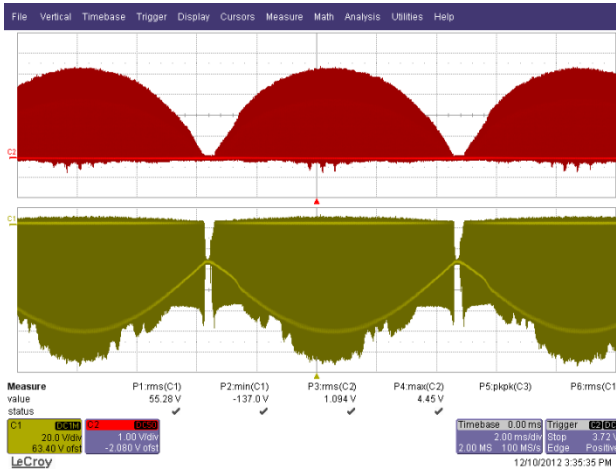

Figure 61 – 132 VAC, 60 Hz.
Upper: I_{D7} , 1 A / div.
Lower: V_{D7} , 20 V, 2 ms / div.

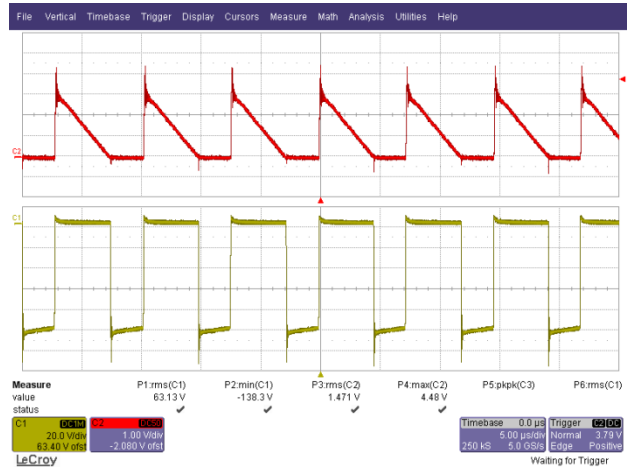

Figure 62 – 132 VAC, 60 Hz.
Upper: I_{D7} , 1 A / div.
Lower: V_{D7} , 20 V / div., 5 μ s / div.



15 Conducted EMI

The design met the limits for conducted electromagnetic emission (EMI) with frequency range of 9 kHz to 30 MHz as per described in the CISPR 15 / IEC: 2005 Standard.

15.1 Test Set-up

The UUT was placed inside a PAR38 with MT-G2 lamp provided by CREE at input voltage of 120 VAC, 60 Hz at room temperature. The unit was placed inside a conical metal housing as shown in Figure 63.



Figure 63 – EMI Test Set-up with the Unit and LED Load Placed Inside a Conical Metal Housing as Described in CISPR 15 / IEC: 2005 Standard.



15.2 Test Result

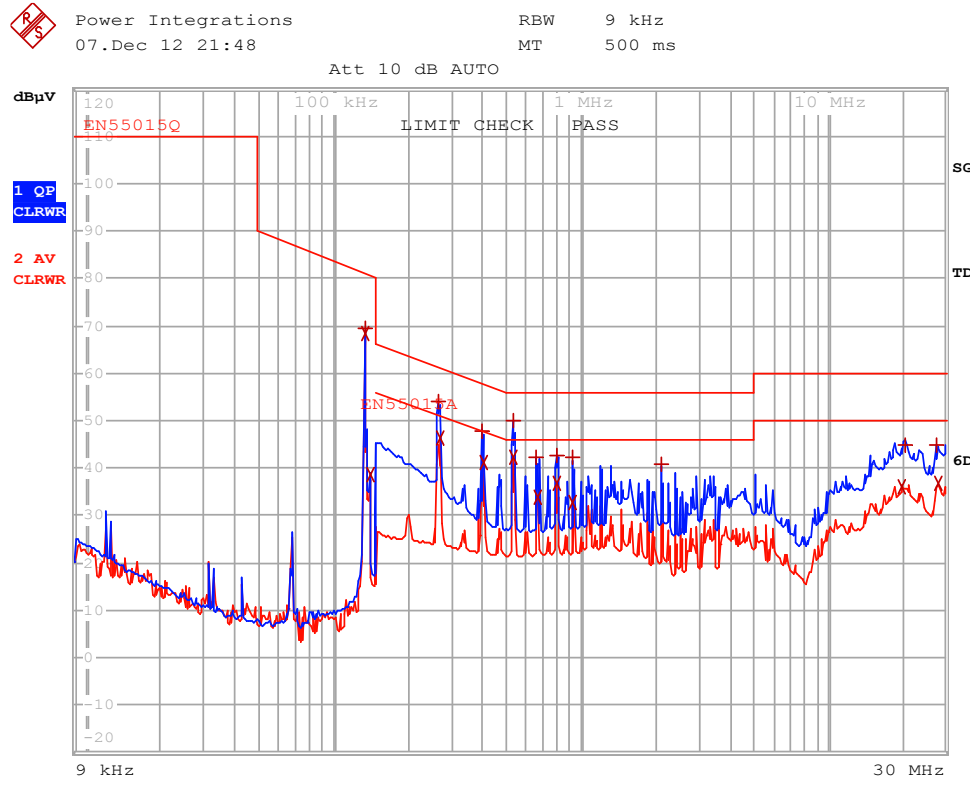

EDIT PEAK LIST (Final Measurement Results)

Trace1: EN55015Q
Trace2: EN55015A
Trace3: ---

TRACE	FREQUENCY	LEVEL dBµV	DELTA LIMIT dB
1 Quasi Peak	133.454986145 kHz	69.43 L1 gnd	-11.62
2 Average	133.454986145 kHz	68.36 N gnd	
2 Average	140.262531674 kHz	38.70 L1 gnd	
1 Quasi Peak	264.49018761 kHz	54.05 L1 gnd	-7.23
2 Average	267.135089486 kHz	46.46 L1 gnd	-4.73
1 Quasi Peak	397.727746704 kHz	47.97 L1 gnd	-9.92
2 Average	401.705024172 kHz	41.31 L1 gnd	-6.50
1 Quasi Peak	530.769219795 kHz	49.87 L1 gnd	-6.12
2 Average	530.769219795 kHz	42.20 L1 gnd	-3.79
1 Quasi Peak	660.656865747 kHz	42.26 L1 gnd	-13.73
2 Average	667.263434405 kHz	33.72 L1 gnd	-12.27
1 Quasi Peak	798.145472681 kHz	42.47 L1 gnd	-13.52
2 Average	798.145472681 kHz	36.78 L1 gnd	-9.21
1 Quasi Peak	926.622115652 kHz	42.24 L1 gnd	-13.75
2 Average	926.622115652 kHz	32.58 L1 gnd	-13.41
1 Quasi Peak	2.11629733595 MHz	40.80 L1 gnd	-15.19
2 Average	19.8557266951 MHz	36.09 L1 gnd	-13.90
1 Quasi Peak	20.4573750697 MHz	44.92 L1 gnd	-15.07
1 Quasi Peak	27.5734507982 MHz	44.75 L1 gnd	-15.24
2 Average	27.8491853062 MHz	36.93 L1 gnd	-13.06

Figure 64 – Conducted EMI, 36 V LED Load, 120 VAC, 60 Hz, and EN55015 B Limits.



16 Line Surge

The unit was subjected to ± 2500 V 100 kHz ring wave and ± 500 V differential surge at 120 VAC using 10 strikes at each condition. A test failure was defined as a non-recoverable interruption of output requiring supply repair or recycling of input voltage.

The unit tested passed both ± 2500 V 100 kHz ring wave and ± 500 V differential surge with and without MOV.

Level (V)	Input Voltage (VAC)	Injection Location	Injection Phase (°)	Type	Test Result (Pass/Fail)
+2500	120	L1, L2	0	100 kHz Ring Wave (500 A)	Pass
-2500	120	L1, L2	0	100 kHz Ring Wave (500 A)	Pass
+2500	120	L1, L2	90	100 kHz Ring Wave (500 A)	Pass
-2500	120	L1, L2	90	100 kHz Ring Wave (500 A)	Pass

Level (V)	Input Voltage (VAC)	Injection Location	Injection Phase (°)	Type	Test Result (Pass/Fail)
+500	120	L1, L2	0	Surge (2 Ω)	Pass
-500	120	L1, L2	0	Surge (2 Ω)	Pass
+500	120	L1, L2	90	Surge (2 Ω)	Pass
-500	120	L1, L2	90	Surge (2 Ω)	Pass

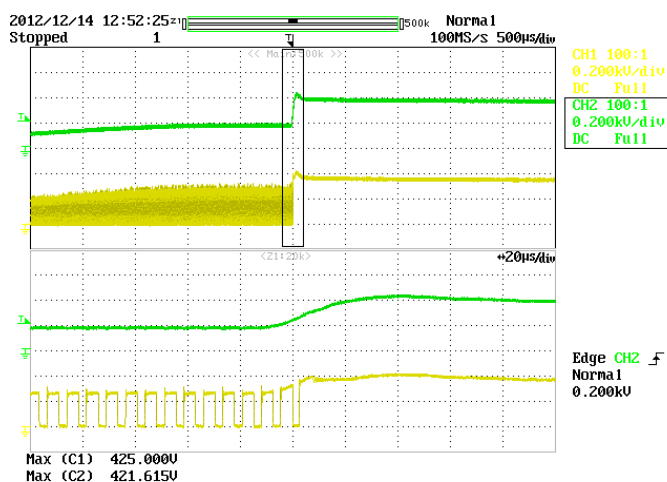

Figure 65 – CH1: 90° 500 V Differential Surge (No MOV).
CH1: U1 VDS.
CH2: C2 Voltage.



17 Revision History

Date	Author	Revision	Description and Changes	Reviewed
13-Nov-12	ME	1.0	Initial release	Apps & Mktg
15-Jan-13	CA	2.0	Design Updated with Inductor	Apps & Mktg
20-May-13	KM	2.1	Changed name to LYTSwitch-4	Apps & Mktg



For the latest updates, visit our website: www.powerint.com

Power Integrations reserves the right to make changes to its products at any time to improve reliability or manufacturability. Power Integrations does not assume any liability arising from the use of any device or circuit described herein. POWER INTEGRATIONS MAKES NO WARRANTY HEREIN AND SPECIFICALLY DISCLAIMS ALL WARRANTIES INCLUDING, WITHOUT LIMITATION, THE IMPLIED WARRANTIES OF MERCHANTABILITY, FITNESS FOR A PARTICULAR PURPOSE, AND NON-INFRINGEMENT OF THIRD PARTY RIGHTS.

PATENT INFORMATION

The products and applications illustrated herein (including transformer construction and circuits' external to the products) may be covered by one or more U.S. and foreign patents, or potentially by pending U.S. and foreign patent applications assigned to Power Integrations. A complete list of Power Integrations' patents may be found at www.powerint.com. Power Integrations grants its customers a license under certain patent rights as set forth at <http://www.powerint.com/ip.htm>.

The PI Logo, TOPSwitch, TinySwitch, LinkSwitch, LYTSwitch, DPA-Switch, PeakSwitch, CAPZero, SENZero, LinkZero, HiperPFS, HiperTFS, HiperLCS, Qspeed, EcoSmart, Clampless, E-Shield, Filterfuse, StackFET, PI Expert and PI FACTS are trademarks of Power Integrations, Inc. Other trademarks are property of their respective companies. ©Copyright 2012 Power Integrations, Inc.

Power Integrations Worldwide Sales Support Locations

WORLD HEADQUARTERS

5245 Hellyer Avenue
San Jose, CA 95138, USA.
Main: +1-408-414-9200
Customer Service:
Phone: +1-408-414-9665
Fax: +1-408-414-9765
e-mail: usasales@powerint.com

GERMANY

Lindwurmstrasse 114
80337, Munich
Germany
Phone: +49-895-527-39110
Fax: +49-895-527-39200
e-mail: eurosales@powerint.com

JAPAN

Kosei Dai-3 Building
2-12-11, Shin-Yokohama,
Kohoku-ku, Yokohama-shi,
Kanagawa 222-0033
Japan
Phone: +81-45-471-1021
Fax: +81-45-471-3717
e-mail: japansales@powerint.com

TAIWAN

5F, No. 318, Nei Hu Rd.,
Sec. 1
Nei Hu District
Taipei 11493, Taiwan R.O.C.
Phone: +886-2-2659-4570
Fax: +886-2-2659-4550
e-mail: taiwansales@powerint.com

CHINA (SHANGHAI)

Rm 1601/1610, Tower 1,
Kerry Everbright City
No. 218 Tianmu Road West,
Shanghai, P.R.C. 200070
Phone: +86-21-6354-6323
Fax: +86-21-6354-6325
e-mail: chinasales@powerint.com

INDIA

#1, 14th Main Road
Vasanthanagar
Bangalore-560052
India
Phone: +91-80-4113-8020
Fax: +91-80-4113-8023
e-mail: indiasales@powerint.com

KOREA

RM 602, 6FL
Korea City Air Terminal B/D,
159-6
Samsung-Dong, Kangnam-Gu,
Seoul, 135-728 Korea
Phone: +82-2-2016-6610
Fax: +82-2-2016-6630
e-mail: koreasales@powerint.com

EUROPE HQ

1st Floor, St. James's House
East Street, Farnham
Surrey GU9 7TJ
United Kingdom
Phone: +44 (0) 1252-730-141
Fax: +44 (0) 1252-727-689
e-mail: eurosales@powerint.com

CHINA (SHENZHEN)

3rd Floor, Block A,
Zhongtuo International Business
Center, No. 1061, Xiang Mei Rd,
FuTian District, ShenZhen,
China, 518040
Phone: +86-755-8379-3243
Fax: +86-755-8379-5828
e-mail: chinasales@powerint.com

ITALY

Via Milanese 20, 3rd Fl.
20099 Sesto San Giovanni
(MI) Italy
Phone: +39-024-550-8701
Fax: +39-028-928-6009
e-mail: eurosales@powerint.com

SINGAPORE

51 Newton Road,
#19-01/05 Goldhill Plaza
Singapore, 308900
Phone: +65-6358-2160
Fax: +65-6358-2015
e-mail: singaporesales@powerint.com

APPLICATIONS HOTLINE

World Wide +1-408-414-9660

APPLICATIONS FAX

World Wide +1-408-414-9760

