Design Example Report

Title	<i>8.4 W High Power Factor CV/CC Isolated Flyback Power Supply Using LYTSwitch™-6 LYT6063C</i>
Specification	90 VAC – 265 VAC Input; 24 V, 350 mA Output
Application	Smart Lighting
Author	Applications Engineering Department
Document Number	DER-617
Date	February 21, 2018
Revision	1.2

Summary and Features

- Accurate constant voltage and constant current regulation (CV/CC)
- High power factor, >0.9 at 115 V and 230 V
- Fast transient load response
- Highly energy efficient, >84 % at 115 V and 230 V
- Integrated protection and reliability features
 - Output short-circuit
 - Line and output OVP
 - Line surge or line overvoltage
 - Thermal foldback and over-temperature shutdown with hysteretic automatic power recovery
- No damage during line brown-out or brown-in conditions
- Meets IEC 2.5 kV ring wave, 2 kV differential surge
- Meets EN55015 conducted EMI

Power Integrations

5245 Hellyer Avenue, San Jose, CA 95138 USA.
Tel: +1 408 414 9200 Fax: +1 408 414 9201
www.power.com

PATENT INFORMATION

The products and applications illustrated herein (including transformer construction and circuits external to the products) may be covered by one or more U.S. and foreign patents, or potentially by pending U.S. and foreign patent applications assigned to Power Integrations. A complete list of Power Integrations' patents may be found at www.powerint.com. Power Integrations grants its customers a license under certain patent rights as set forth at <http://www.powerint.com/ip.htm>.



Table of Contents

1	Introduction.....	5
2	Power Supply Specification.....	7
3	Schematic.....	8
4	Circuit Description	9
4.1	Input EMI Filter and Rectifier	9
4.2	LYTSwitch-6 Primary Side Control	9
4.3	LYTSwitch-6 Secondary Side Control	10
4.4	Intelligent Quasi-Resonant Mode Switching.....	11
4.5	PFC Circuit Operation	12
5	PCB Layout.....	13
6	Bill of Materials	14
6.1	Main Bill of Materials	14
6.2	Miscellaneous Parts.....	14
7	Flyback Transformer (T1) Specification	15
7.1	Electrical Diagram.....	15
7.2	Electrical Specifications	15
7.3	Material List	15
7.4	Transformer Build Diagram.....	16
7.5	Transformer Construction	16
7.6	Transformer Winding Illustrations	17
8	PFC Inductor (T2) Specifications.....	22
8.1	Electrical Diagram.....	22
8.2	Electrical Specifications	22
8.3	Material List	22
8.4	Inductor Build Diagram	23
8.5	Inductor Construction	23
8.6	Inductor Winding Illustrations.....	24
9	Design Spreadsheet.....	26
10	Performance Data	30
10.1	CV/CC Output Characteristic Curve.....	30
10.2	System Efficiency.....	31
10.3	Output Voltage Regulation.....	32
10.4	Power Factor.....	33
10.5	%ATHD	34
10.6	Individual Harmonics Content at Full Load	35
10.7	No-Load Input Power	36
11	Test Data	38
11.1	Test Data at Full Load.....	38
11.2	Test Data at No-Load.....	38
11.3	Individual Harmonic Content at 230 VAC 50 Hz and Full Load.....	39
12	Load Regulation Performance	40
12.1	Output Voltage Load Regulation.....	40

12.2	Efficiency vs. Load	41
12.3	Average Efficiency	41
12.4	Power Factor vs. Load.....	42
12.5	% ATHD vs. Load	43
13	Thermal Performance.....	44
13.1	Thermal Scan at 25 °C Ambient.....	44
13.1.1	Thermal Scan at 90 VAC Full Load	45
13.1.2	Thermal Scan at 115 VAC Full Load	46
13.1.3	Thermal Scan at 230 VAC Full Load	47
13.1.4	Thermal Scan at 265 VAC Full Load	48
13.2	Thermal Performance at 70 °C Ambient	49
14	Waveforms.....	50
14.1	Input Voltage and Input Current at Full Load	50
14.2	Start-up Profile at Full Load	51
14.3	Output Voltage Fall.....	52
14.4	Power Cycling	53
14.5	Load Transient Response 3 Hz.....	54
14.6	Load Transient Response 100 Hz	55
14.7	LYTSwitch-6 Drain Voltage and Current Waveforms.....	56
14.8	LYTSwitch-6 Drain Voltage and Current at Full Load Start-up	58
14.9	LYTSwitch-6 Drain Voltage and Current During Output Short-Circuit	59
14.10	Input Power During Output Short-Circuit.....	59
14.11	Output Ripple Voltage.....	60
15	Conducted EMI.....	61
15.1	Test Set-up	61
15.2	Equipment and Load Used.....	61
15.3	EMI Test Result.....	62
16	Line Surge.....	64
16.1	Differential Surge Test Results.....	64
16.2	Ring Wave Surge Test Results	64
16.3	2 kV Differential Surge Test.....	65
16.4	2.5 kV Ring Wave Surge Test	66
17	Brown-in / Brown-out Test	67
18	Revision History.....	68

Important Note: Although this board is designed to satisfy safety isolation requirements, the engineering prototype has not been agency approved. Therefore, all testing should be performed using an isolation transformer to provide the AC input to the prototype board.



1 Introduction

This engineering report describes a constant voltage (CV) output 8.4 W isolated flyback power supply with a single stage power factor correction circuit for smart lighting applications. The power supply is designed to provide a 24 V constant voltage across 0 mA to 350 mA output current load. The board is optimized to operate with an input voltage range of 90 VAC to 265 VAC.

The LYTSwitch-6 ICs combine primary, secondary and feedback circuits in a single surface mounted off-line flyback switcher IC. It incorporates the primary MOSFET, the primary-side controller and a secondary-side synchronous rectification controller. The device also includes an innovative new technology, FluxLink™, which safely bridges the isolation barrier and eliminates the need for an optocoupler.

The single-stage power factor correction circuit is added to meet the high PF requirement in lighting applications. The topology is similar to boost topology with its power switch shared with the isolated flyback converter. The energy stored across the PFC inductor is delivered to the load via direct energy transfer reducing the power loss.

DER-617 using a LYTSwitch-6 IC offers an accurate, fast transient response, constant voltage supply with a high power factor throughout the input range. The key design goals were high efficiency and high power factor throughout the input voltage ranges.

The document contains the power supply specification, schematic, bill of materials, transformer documentation, printed circuit layout, and performance data.

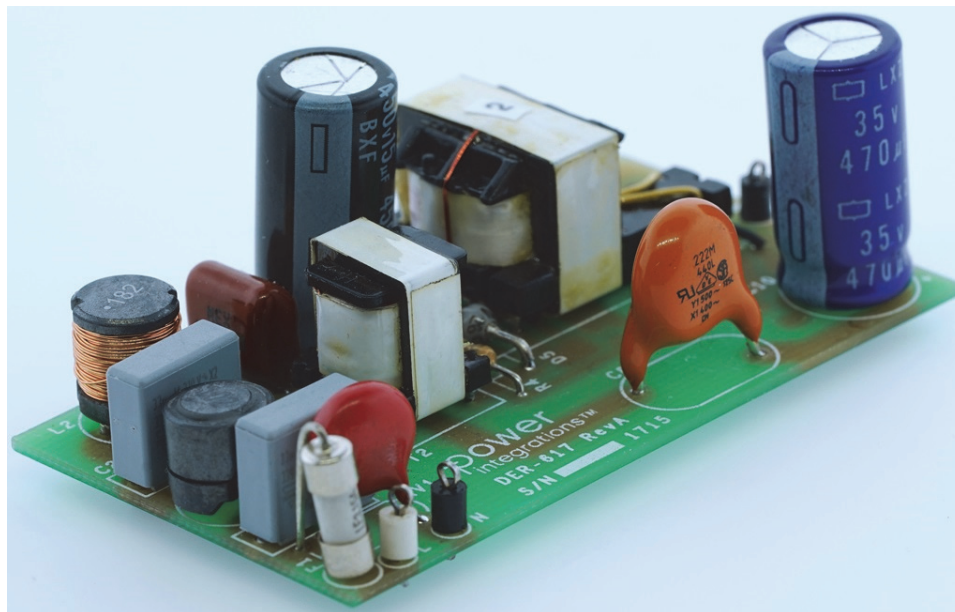

Figure 1 – Populated Circuit Board.

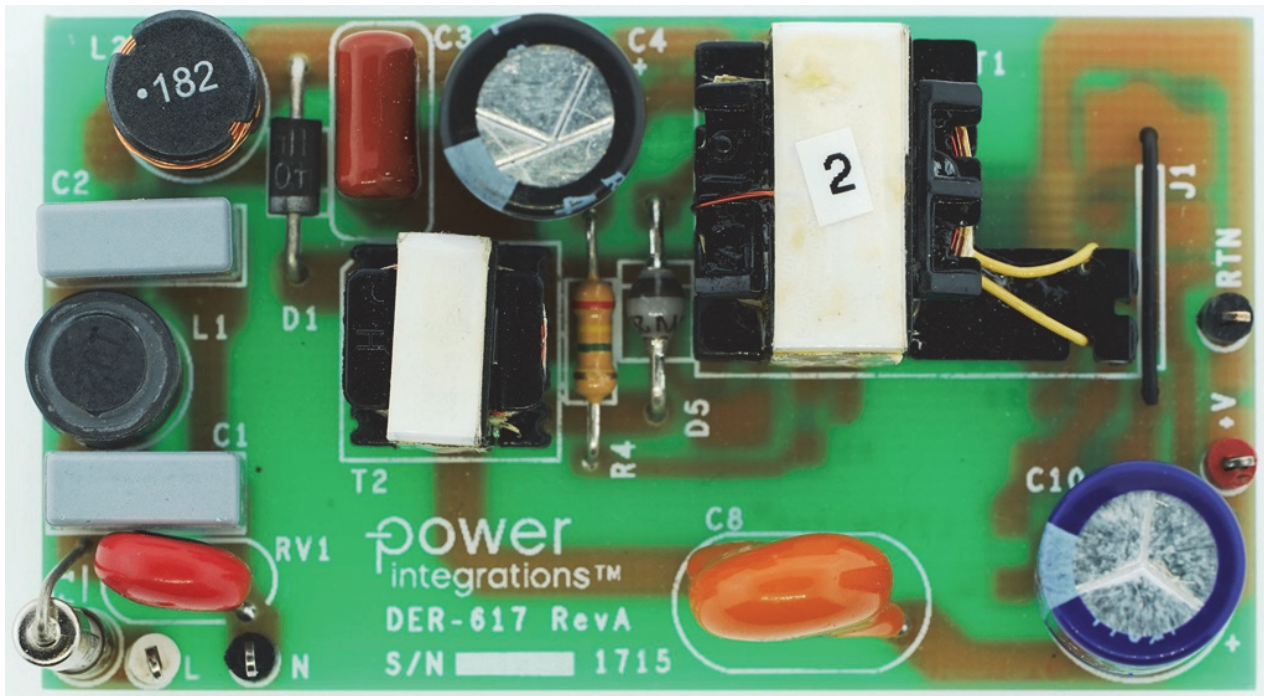

Figure 2 – Populated Circuit Board, Top View

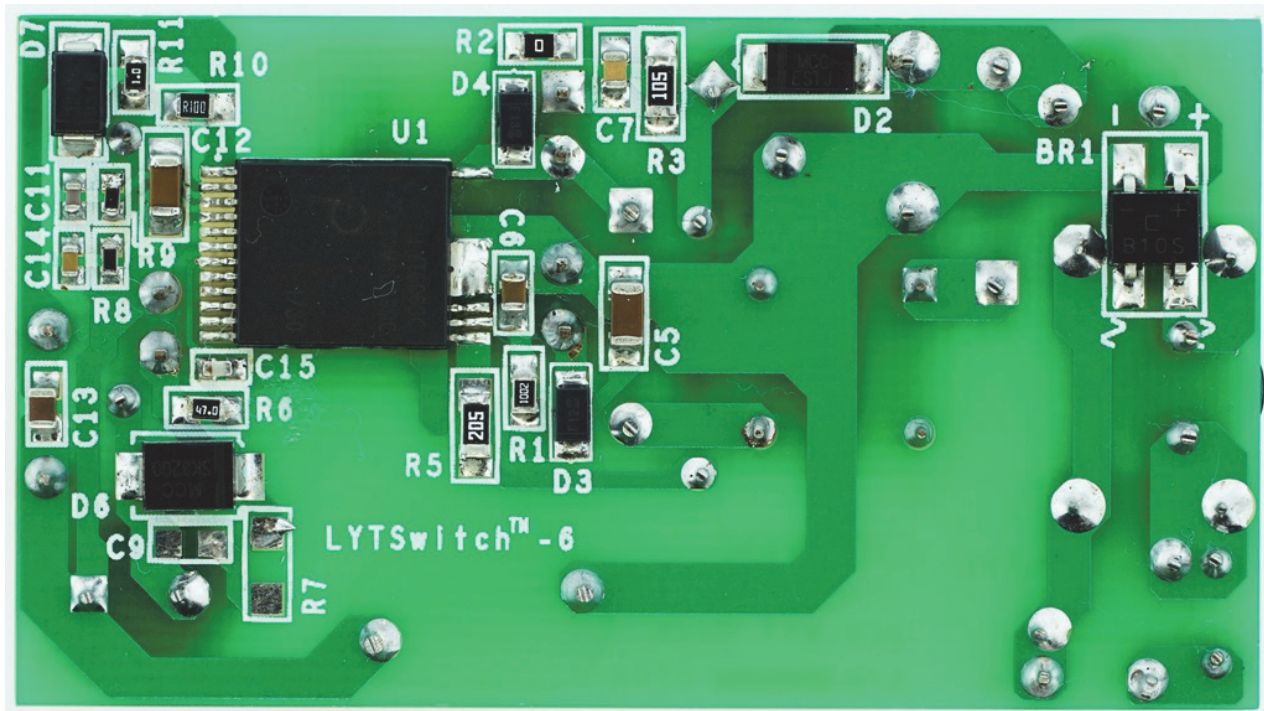

Figure 3 – Populated Circuit Board, Bottom View.

2 Power Supply Specification

The table below represents the minimum acceptable performance of the design. Actual performance is listed in the results section.

Description	Symbol	Min	Typ	Max	Units	Comment
Input Voltage Frequency	V_{IN} f_{LINE}	90	115/60 230/50	265	VAC/Hz	2 Wire – no P.E.
Output Output Voltage Output Current Total Output Power Continuous Output Power	V_{OUT} I_{OUT} P_{OUT}		24 350 8.4		V mA W	
Efficiency Full Load Average Efficiency	η		84 80.93		% %	At 115 V / 60 Hz and 230 V / 50 Hz. at 25 °C Ambient Temperature. DOE Level VI.
Environmental Conducted EMI Safety Ring Wave (100 kHz) Differential Mode (L1-L2)			CISPR 15B / EN55015B Isolated 2.5 2.0		kV kV	
Power Factor			0.9			Measured at 115V / 60 Hz. and 230 VAC / 50 Hz.
Ambient Temperature	T_{AMB}			70	°C	Free Air Convection, Sea Level.

4 Circuit Description

The LYTSwitch-6 (LYT6XX3C) ICs incorporate a high-voltage power MOSFET switch, along with both primary-side and secondary-side controllers in one device. This IC also includes an innovative new technology, FluxLink™, which safely bridges the isolation barrier and eliminates the need for an optocoupler. The LYTSwitch-6 IC is configured to drive an 8.4 W flyback power supply in parallel with a single-stage boost PFC providing a high power factor 24 V constant voltage supply throughout the input range of 90 VAC to 265 VAC.

4.1 Input EMI Filter and Rectifier

The input fuse F1 provides safety protection from component failures. Varistor RV1 acts as a voltage clamp that limits the voltage spike on the primary during line transient voltage surge events. A 275 V rated part was selected, being slightly above the maximum specified operating input voltage (265 V). The AC input voltage is full wave rectified by BR1 to achieve good power factor and low THD.

The bulk capacitor (C4) provides input line ripple voltage filtering for a stable flyback DC supply voltage. It also stores additional energy generated by the PFC during the power switch turn off time.

Capacitor C1, L1, C2, L2, C3 and C4 forms a 2-stage LC EMI filter to suppress differential mode noise caused by the PFC and flyback switching action. Common mode noise is suppressed by Y-capacitor C8.

Rectifier diode (D2) provides a bypass charging current to the bulk capacitor (C4) from the input rectified voltage. Diode (D2) also serves as a blocking diode during the power MOSFET turn on to isolate the flyback DC supply from the PFC supply maintaining the functionality of the added PFC circuit.

4.2 LYTSwitch-6 Primary Side Control

The primary controller on the LYTSwitch™-6 IC is a quasi-resonant (QR) flyback controller that has the ability to operate in continuous conduction mode (CCM). The controller uses both variable frequency and variable current control schemes. The primary controller consists of a frequency jitter oscillator; a receiver circuit magnetically coupled to the secondary controller, a current limit controller, 5 V regulator on the PRIMARY BYPASS pin, audible noise reduction engine for light load operation, bypass overvoltage detection circuit, a lossless input line sensing circuit, current limit selection circuitry, over-temperature protection, leading edge blanking, secondary output diode / SR MOSFET short protection circuit and a 650 V power MOSFET.

One side of the transformer (T1) primary is connected to the positive output terminal of the bulk capacitor (C4) while the other side is connected to the integrated 650 V power MOSFET inside the LYTSwitch-6 (U1) IC. A low cost RCD clamp formed by D4, C7 and R3

limits the peak drain leakage voltage spike due to the effects of transformer leakage inductance.

The VOLTAGE MONITOR (V) pin of LYTSwitch-6 IC is connected to the positive bulk capacitor (C4) to provide input voltage information. The voltage across the bulk capacitor (C4) is sensed and converted into current through (V) pin resistors R4 and R5 to provide detection of input undervoltage and overvoltage. The I_{UV+} and I_{UV-} values determine the brown-in and brown-out threshold while the I_{OV-} determines the input overvoltage threshold. The V pin is internally connected to a high-voltage MOSFET inside the device.

During the initial power-up, the internal high-voltage current source charges the (BPP) pin capacitor (C6). Before switching, the primary will pause for around 80 ms to listen for a secondary request signal. Once switching begins after power up, the primary assumes control until handshake occurs and control is passed over to the secondary-side. The LYTSwitch-6 IC is at normal operation when switching with the secondary control. During normal operation, the primary-side block is powered by the auxiliary winding of the transformer. The auxiliary winding is configured as a flyback winding with its output rectified, filtered (D3 and C5) and fed to the BPP pin via a current limiting resistor R1.

The thermal shutdown circuitry senses the primary MOSFET die temperature. The threshold (T_{SD}) is typically set to 142 °C with 70 °C hysteresis $T_{SD(H)}$. When the die temperature rises above this threshold the power MOSFET is disabled and remains disabled until the die temperature falls by $T_{SD(H)}$ at which point it is re-enabled. A large hysteresis of 70 °C is provided to prevent over-heating of the PCB due to continuous fault condition.

4.3 LYTSwitch-6 Secondary Side Control

The secondary-side control consists of a transmitter circuit that is magnetically coupled to the primary receiver, a constant voltage (CV) and a constant current (CC) control circuit, a 4.4 V regulator on the secondary SECONDARY BYPASS pin, synchronous rectifier MOSFET driver, QR mode circuit, oscillator and timing functions, and a host of integrated protection features.

The secondary voltage of the transformer is rectified by a low V_F Schottky diode D6 and then filtered by the output capacitor C10. Adding a RC snubber across the output diode reduces voltage stress on the diode and the LYTSwitch-6 (FWD) pin but will greatly affect the system efficiency. A simple replacement for the lossy RC snubber is a filter capacitor C15 connected across the FWD pin and GND pin. Capacitor C15 reduces the voltage stress on the FWD pin with minimal effect on system efficiency.

SYNCHRONOUS RECTIFIER DRIVE (SR) pin is connected to the secondary GND pin to allow the use of a cheaper schottky output diode instead of using an SR FET.

The secondary-side of the IC is self-powered from either the secondary bias winding forward voltage or the 24 V regulated output. During CV operation, the regulated output is fed to the VO pin. Current is drawn from the VO pin for the secondary-side of the LYTSwitch-6 IC. During CC operation, when the output voltage falls the device will power itself from the secondary bias winding directly. During the on-time of the primary side MOSFET the forward voltage that appears across the secondary winding is used to charge the BPS pin capacitor C12 via FWD pin resistor R6 and an internal regulator.

During constant voltage mode operation, output voltage regulation is achieved through sensing the output voltage via divider resistors R8 and R9. The voltage across R9 is fed into the FB pin with an internal reference voltage threshold of 1.265 V. Filter capacitor C14 and C11 were added across R8 and R9 respectively to eliminate unwanted noise that might trigger the OVP function or increase the output ripple voltage.

Output current is sensed externally via sense resistors R10 and R11 between the IS and GND pins with a threshold of 35 mV to minimize losses. Once the internal current sense threshold is exceeded, the device adjusts the switching frequency to maintain a fixed output current. Diode D7 serves as a voltage clamp during output short-circuit condition to protect the IS pin and current sense resistors from overvoltage stress generated by high surge current passing through the current sense resistors.

The thermal foldback is activated when the secondary controller die temperature reaches 124 °C, the output power is reduced by reducing the constant current reference threshold

4.4 Intelligent Quasi-Resonant Mode Switching

In order to improve conversion efficiency and reduce switching losses, the LYTSwitch™-6 IC features a means to allow switching when the voltage across the primary switch is near its minimum voltage when the converter operates in critical (CRM) or discontinuous conduction mode (DCM). This mode of operation is automatically detected in CRM or DCM and disabled once the converter operates in continuous-conduction mode (CCM).

Rather than detecting the magnetizing ring valley on the primary-side, the peak voltage of the FORWARD pin voltage as it rises above the output voltage level is used to gate secondary request to initiate the switch "ON" cycle in the primary controller. The secondary controller detects when the controller enters in discontinuous-mode and opens secondary cycle request windows corresponding to minimum switching voltage across the primary power MOSFET.

Quasi-resonant (QR) mode is enabled for the first four resonant rings. QR switching is disabled after the 4th relaxation event, at which point switching may occur at any time a secondary request is initiated. The secondary controller includes blanking of ~1 ms to

prevent false detection of primary "ON" cycle when the FORWARD pin rings below ground.

4.5 PFC Circuit Operation

Without the added PFC circuit, the power factor of the flyback power supply is normally around 0.5 to 0.6 at full load condition. The input of the flyback power supply circuit usually consists of the full wave bridge rectifier (BR1) followed by a storage bulk capacitor (C4) capable of maintaining a voltage approximately equal to the peak voltage of the input sine wave until the next peak comes to recharge the capacitor. The input charging pulse current must be high enough to sustain the load until the next peak. This means that the charging pulse current is around 5-10 times higher than the average current with a high phase angle difference from the voltage waveform.

The added PFC circuit is similar to a boost topology comprising of a pfc inductor (T2) and pfc diodes (D1 and D5) connected directly to the DRAIN pin of the LYTSwitch-6 IC. The idea is to use the LYTSwitch-6 IC flyback switching action to be able to draw a high frequency pulse current from the full wave rectified input. This will reduce the rms input current and the phase angle difference from the input line voltage which results to an increased power factor.

The PFC inductor T2 operates in DCM mode. During the power MOSFET turn on time, current drawn from the rectified input ramps through the boost inductor (T2) storing energy. The stored energy on T2 is then delivered to the load via direct energy transfer between the primary and secondary winding of the flyback transformer T1. The variability of the PFC inductor peak current will be compensated by LYTSwitch-6 IC primary and secondary-side control maintaining the voltage regulation at all conditions.

Leakage energy stored on the leakage inductance of transformer T1 during turn on will be delivered to the storage bulk capacitor C4 during power MOSFET turn off time. The expected voltage stress across the bulk capacitor C4 will be higher than the peak input voltage. 2 PFC diodes D1 and D5 are connected in series to withstand voltage stress caused by the resonance ringing of inductor T2 during the MOSFET turn off.

5 PCB Layout

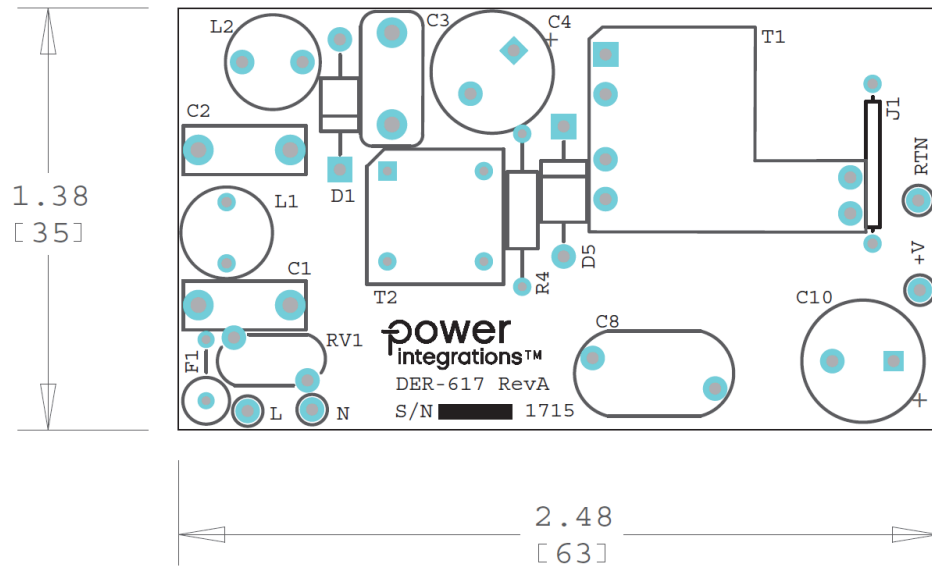

Figure 5 – Top Side.

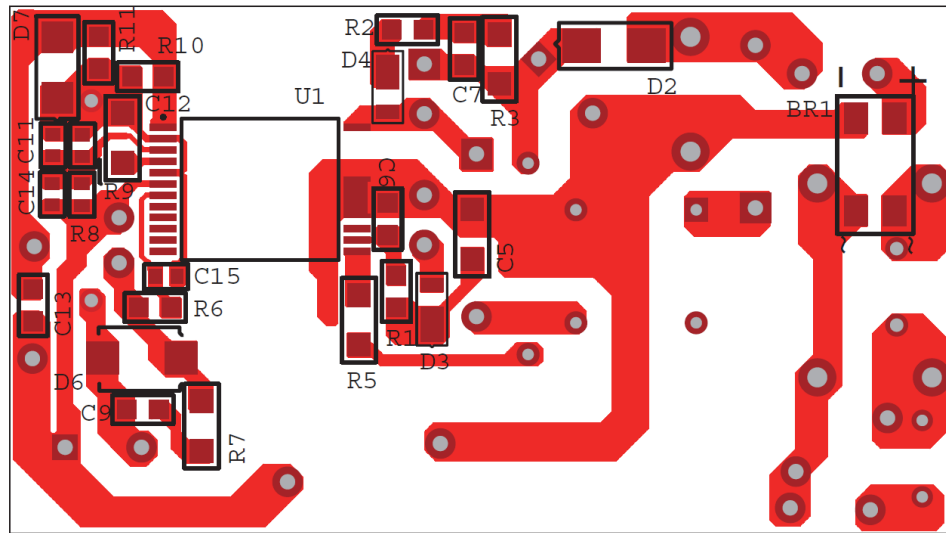

Figure 6 – Bottom Side.

6 Bill of Materials

6.1 Main Bill of Materials

Item	Qty	Ref Des	Description	Mfg	Mfg Part Number
1	1	BR1	1000 V, 0.8 A, Bridge Rectifier, SMD, MBS-1, 4-SOIC	B10S-G	Comchip
2	2	C1 C2	33 nF, 310 VAC, Polyester Film, X2	BFC233920333	Vishay
3	1	C3	100 nF, 450 V, Film	MEXXD31004JJ1	Duratech
4	1	C4	15 μ F, 450 V, Electrolytic, (10 x 20)	450BXF15M10X20	Rubycon
5	1	C5	22 μ F, 35 V, Ceramic, X5R, 1206	C3216X5R1V226M160AC	TDK
6	1	C6	470 nF, 50 V, Ceramic, X7R, 0805	GRM21BR71H474KA88L	Murata
7	1	C7	1.5 nF, 200 V, 10%, Ceramic, X7R, 0805	08052C152KAT2A	AVX
8	1	C8	2.2 nF, Ceramic, Y1	440LD22-R	Vishay
9	1	C10	470 μ F, 35 V, Electrolytic, Low ESR, 52 m Ω	ELXZ350ELL471MJ20S	Nippon Chemi-Con
10	1	C11	330 pF 50 V, Ceramic, X7R, 0603	CC0603KRX7R9BB331	Yageo
11	1	C12	2.2 μ F, 25 V, Ceramic, X7R, 1206	TMK316B7225KL-T	Taiyo Yuden
12	1	C13	1 μ F, 50 V, Ceramic, X7R, 0805	C2012X7R1H105M085AC	TDK
13	1	C14	100 nF 50 V, Ceramic, X7R, 0603	C1608X7R1H104K	TDK
14	1	C15	68 pF, \pm 5%, 200V, Ceramic, COG, NP0, 0603	C0603C680J2GACTU	Kemet
15	1	D1	600 V, 1 A, Ultrafast Recovery, 75 ns, DO-41	UF4005-E3	Vishay
16	1	D2	600 V, 1 A, Super Fast, 35 ns, DO-214AC, SMA	ES1J-LTP	Micro Commercial
17	1	D3	DIODE, UFAST, 200 V, 1 A, POWERDI123	DFLU1200-7	Diodes, Inc.
18	1	D4	600 V, 1 A, Rectifier, Glass Passivated, POWERDI123	DFLR1600-7	Diodes, Inc.
19	1	D5	600 V, 1 A, Ultrafast Recovery, 30 ns, SOD57	BYV26C	Philips
20	1	D6	200 V, 3 A, DIODE SCHOTTKY 1 A 200 V, SMB	SK3200B-LTP	Micro Commercial
21	1	D7	DIODE ULTRA FAST, 1 A, 100 V, SMA	US1B-13-F	Diodes, Inc.
22	1	F1	3.15 A, 250 V, Slow, 3.6 mm x 10 mm, Axial	08773.15MXEP	Littlefuse
23	1	L1	1 mH, 0.23 A, Ferrite Core	CTSCH875DF-102K	CT Parts
24	1	L2	1.8 mH, 350 mA	768772182	Würth
25	1	R1	RES, 10 k Ω , 1%, 1/8 W, Thick Film, 0805	ERJ-6ENF1002V	Panasonic
26	1	R2	RES, 0 Ω , 5%, 1/8 W, Thick Film, 0805	ERJ-6GEY0R00V	Panasonic
27	1	R3	RES, 1 M Ω , 5%, 1/4 W, Thick Film, 1206	ERJ-8GEYJ105V	Panasonic
28	1	R4	RES, 2.4 M Ω , 5%, 1/4 W, Carbon Film	CFR-25JB-2M4	Yageo
29	1	R5	RES, 2.00 M Ω , 1%, 1/4 W, Thick Film, 1206	ERJ-8ENF2004V	Panasonic
30	1	R6	RES, 47 Ω , 5%, 1/8 W, Thick Film, 0805	ERJ-6GEYJ470V	Panasonic
31	1	R8	RES, 102 k Ω , 1%, 1/16 W, Thick Film, 0603	ERJ-3EKF1023V	Panasonic
32	1	R9	RES, 5.62 k Ω , 1%, 1/16 W, Thick Film, 0603	ERJ-3EKF5621V	Panasonic
33	1	R10	RES, 0.1 Ω , \pm 1%, 0.125 W, 1/8 W, 0805	RL0805FR-070R1L	Yageo
34	1	R11	RES, 1.00 Ω , 1%, 1/8 W, 0805, Thick Film	RMCF0805FT1R00	Stackpole
35	1	RV1	275 VAC, 23 J, 7 mm, RADIAL	V275LA4P	Littlefuse
36	1	T1	Bobbin, EE1621, Vertical, 8 pins, 4pri, 4sec	EE-1621	Shen Zhen Xin Yu Jia
37	1	T2	Bobbin, EE10, Vertical, 8 pins	EE-1016	Yulongxin
38	1	U1	LYTSwitch-6 Integrated Circuit, InSOP24D	LYT6063C	Power Integrations

6.2 Miscellaneous Parts

Item	Qty	Ref Des	Description	Mfg	Mfg Part Number
1	1	+V	Test Point, RED, Miniature THRU-HOLE MOUNT	5000	Keystone
2	1	L	Test Point, BLUE, Miniature THRU-HOLE MOUNT	5117	Keystone
3	1	N	Test Point, WHT, Miniature THRU-HOLE MOUNT	5002	Keystone
4	1	RTN	Test Point, BLK, Miniature THRU-HOLE MOUNT	5001	Keystone



7 Flyback Transformer (T1) Specification

7.1 Electrical Diagram

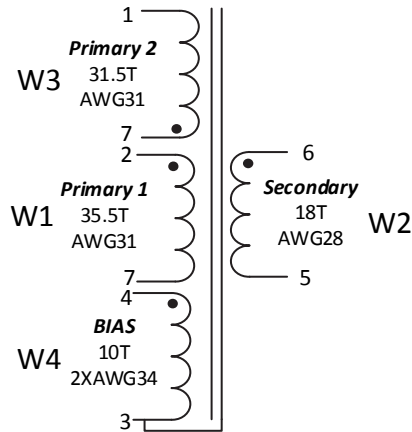

Figure 7 – Transformer Electrical Diagram.

7.2 Electrical Specifications

Parameter	Condition	Spec.
Nominal Primary Inductance	Measured at 1 V _{PK-PK} , 100 kHz switching frequency, between pin 1 and pin 2 with all other windings open.	1550 μH
Tolerance	Tolerance of Primary Inductance.	±5%

7.3 Material List

Item	Description
[1]	Core: EE1621.
[2]	Bobbin, EE1621, Vertical, 8 pins, 4pri, 4sec, Part No.: 25-01044-00.
[3]	Magnet Wire: #31 AWG.
[4]	Magnetic Wire: #34 AWG.
[5]	TIW: #28 AWG.
[6]	Polyester Tape: 5.5 mm.
[7]	Polyester Tape: 6 mm.

7.4 Transformer Build Diagram

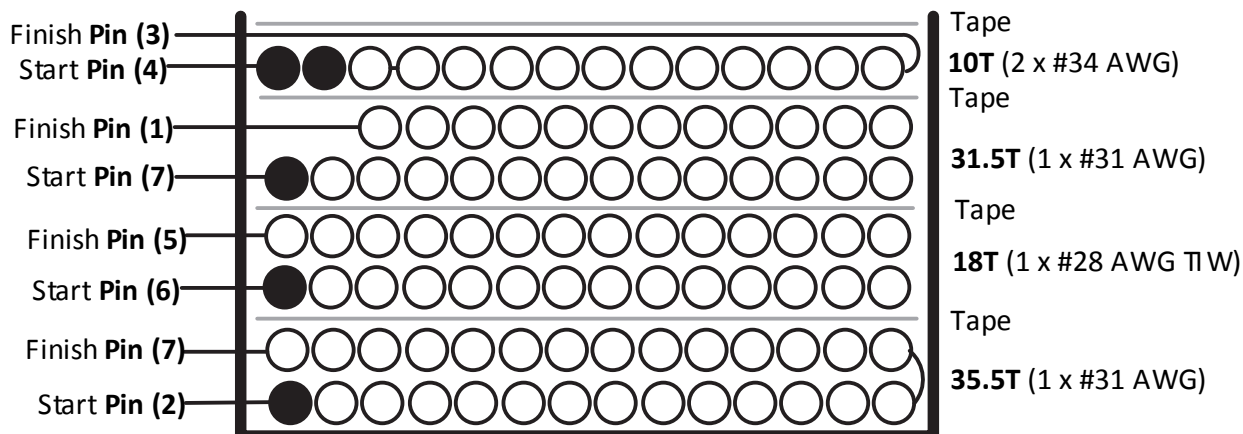

7.5 Transformer Construction

Winding Directions	Bobbin is oriented on winder jig such that terminal pin 1-4 is in the left side. The winding direction is clockwise.
Winding 1	Use magnetic wire Item [3]. Start at pin 2 and wind 35.5 turns evenly in 2 layers. Finish the winding on pin 7.
Insulation	Apply 1 layer of polyester tape, Item [6] for insulation
Winding 2	Use triple insulated wire Item [5]. Start at pin 6 and wind 18 turns evenly in 2 layers. Finish the winding on pin 5.
Insulation	Apply 1 layer of polyester tape, Item [6] for insulation
Winding 3	Use magnetic wire Item [3]. Start at pin 7 and wind 31.5 turns evenly in 2 layers. Finish the winding on pin 1.
Insulation	Apply 1 layer of polyester tape, Item [6] for insulation
Winding 4	Use magnetic wire Item [4]. Prepare the wire for bifilar type wound. Start at pin 4 and wind 10 turns from left to right. Finish the winding on pin 3.
Insulation	Apply 1 layer of polyester tape, Item [6] for insulation
Core Grinding	Grind the center leg of the ferrite core to meet the nominal inductance specification of 1550 μ H.
Assemble Core	Assemble the 2 cores into the bobbin
Core Termination	Prepare a copper strip with a soldered magnetic wire (#AWG 32) at the middle as shown in the figure. Apply copper strip on top of the core and terminate the magnetic wire on pin 3.
Bobbin Tape	Add 2 Layers of polyester tape, Item [7] around the core to fix the 2 cores into the bobbin.
Pins	Cut terminal pin 7. Pull out terminal pin 8.
Finish	Dip the transformer in a 2:1 varnish and thinner solution.

7.6 Transformer Winding Illustrations

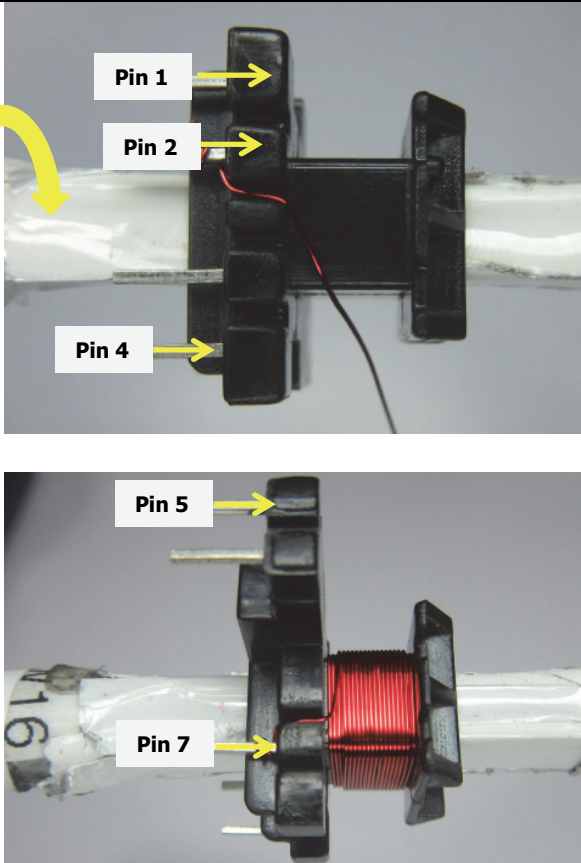
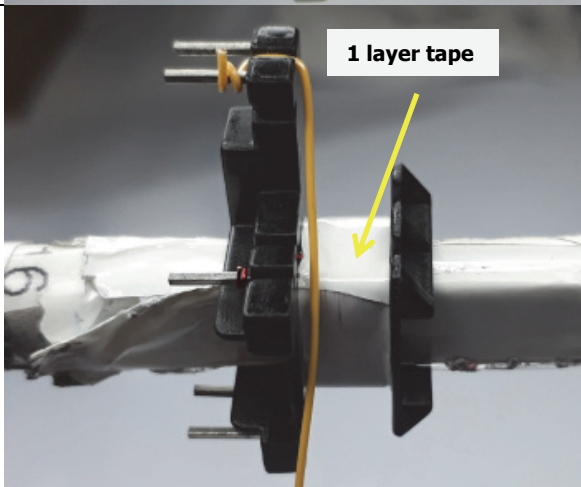
<p>Winding Directions Bobbin is oriented on winder jig such that terminal pin 1-4 is in the left side. The winding direction is clockwise.</p> <p>Winding 1 Use magnetic wire Item 3. Start at pin 2 and wind 35.5 turns evenly in 2 layers.</p> <p>Finish the winding on pin 7.</p>	
<p>Insulation Apply 1 layer of polyester tape, Item [6] for insulation.</p>	

Winding 2

Use triple insulated wire Item [5]. Start at pin 6 and wind 18 turns evenly in 2 layers.

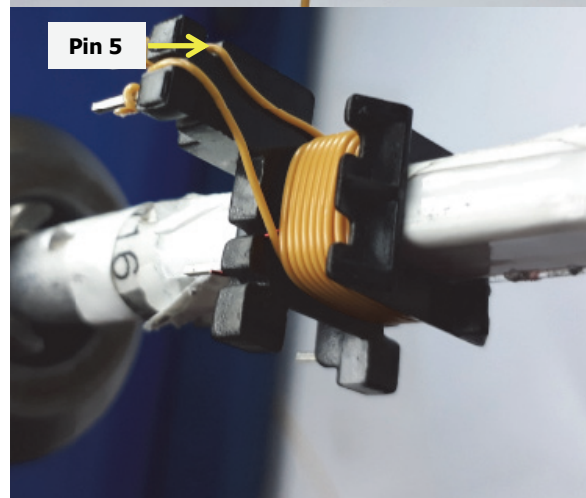
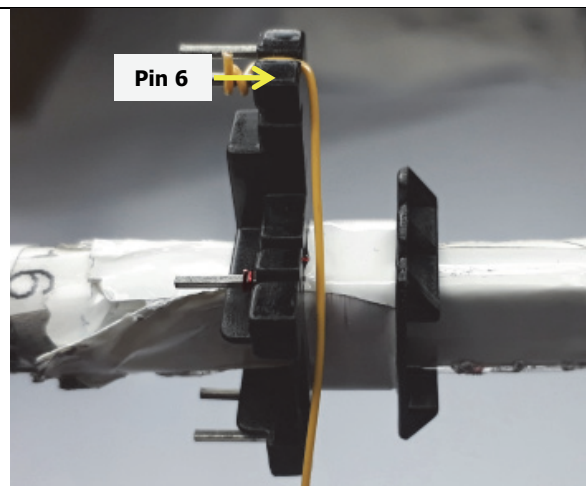

Finish the winding on pin 5.

Insulation

Apply 1 layer of polyester tape, Item [6] for insulation.

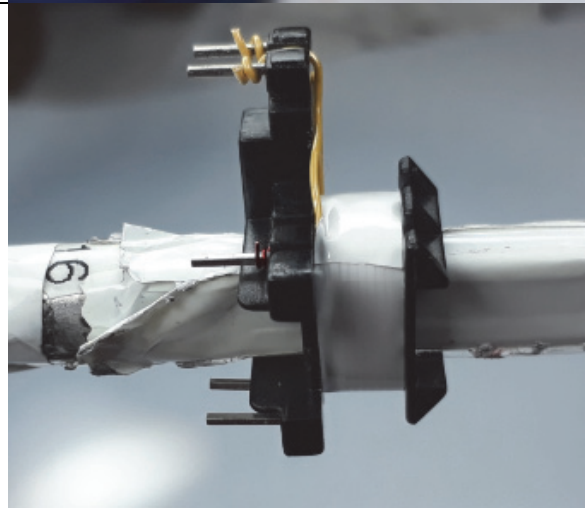

Winding 3

Use magnetic wire Item 3. Start at pin 7 and wind 31.5 turns evenly in 2 layers.

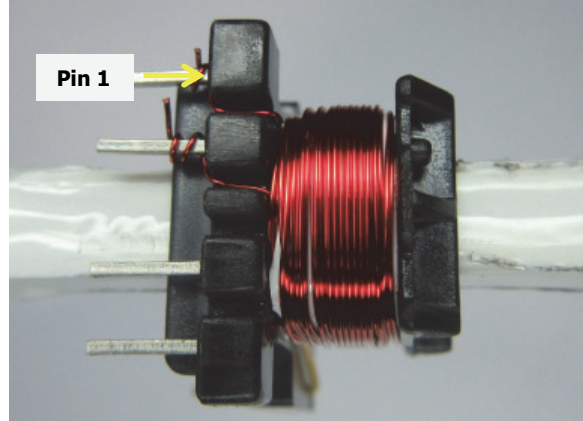
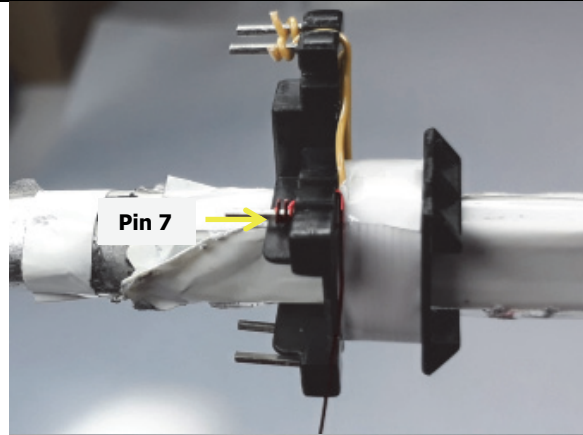

Finish the winding on pin 1.

Insulation

Apply 1 layer of polyester tape, Item [6] for insulation.

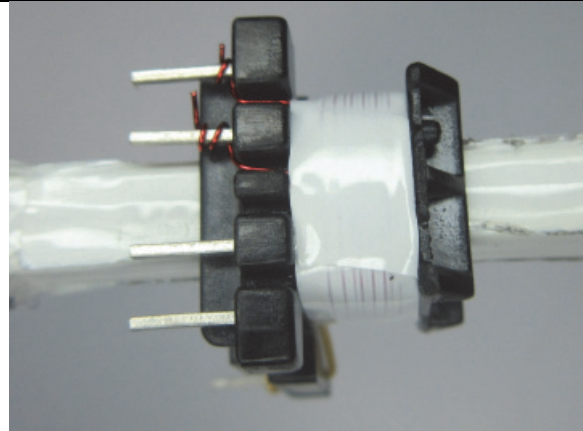

Winding 4

Use magnetic wire Item (4). Prepare the wire for bifilar wound. Start at pin 4 and wind 10 turns from left to right.

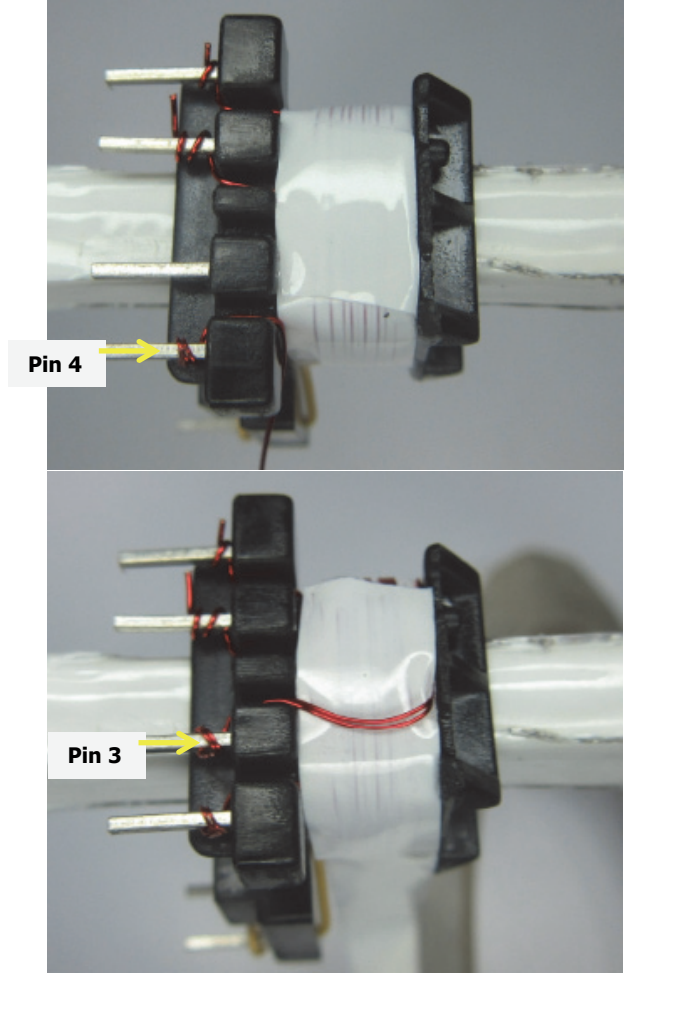

Finish the winding on pin 3.

Insulation

Apply 1 layer of polyester tape, Item [6] for insulation

Core Termination

Prepare a copper strip with a soldered magnetic wire (#AWG 32) at the middle as shown in the figure. Apply copper strip on top of the core and terminate the magnetic wire on pin 3

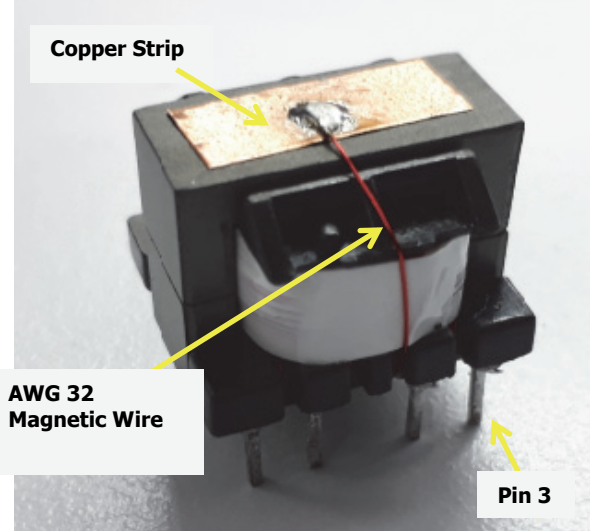

Core Tape

Add 2 Layers of polyester tape, Item [7] around the core to fix the 2 cores into the bobbin.

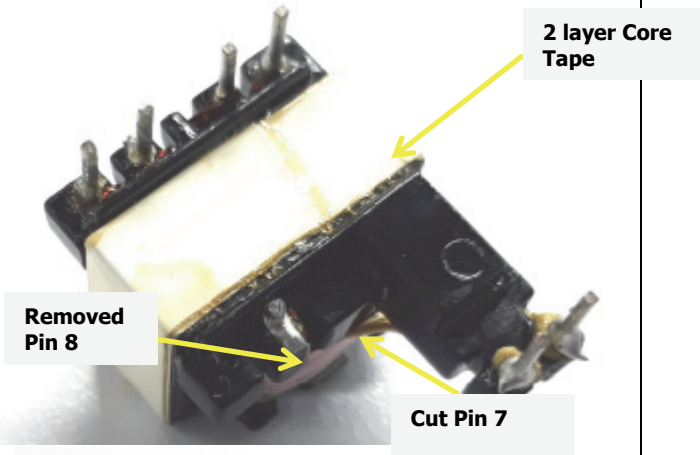

Pins

Cut terminal pin 7. Pull out terminal pin 8.

Varnishing

Dip the transformer in a 2:1 varnish and thinner solution.



8 PFC Inductor (T2) Specifications

8.1 Electrical Diagram

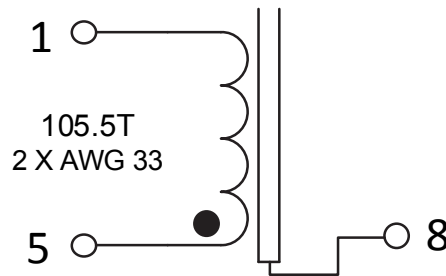

Figure 9 – Inductor Electrical Diagram.

8.2 Electrical Specifications

Parameter	Condition	Spec.
Nominal Primary Inductance	Measured at 1 V_{PK-PK} , 100 kHz switching frequency, between pin 1 and pin 5, with all other windings open.	1200 μ H
Tolerance	Tolerance of Primary Inductance.	$\pm 5\%$

8.3 Material List

Item	Description
[1]	Core: EE10.
[2]	Bobbin: Bobbin, EE10, Vertical, 8 pins: Part no. 25-01068-00.
[3]	Magnet Wire: #33 AWG.
[5]	Transformer Tape: 6.5 mm.
[6]	Transformer Tape: 4 mm.

8.4 Inductor Build Diagram

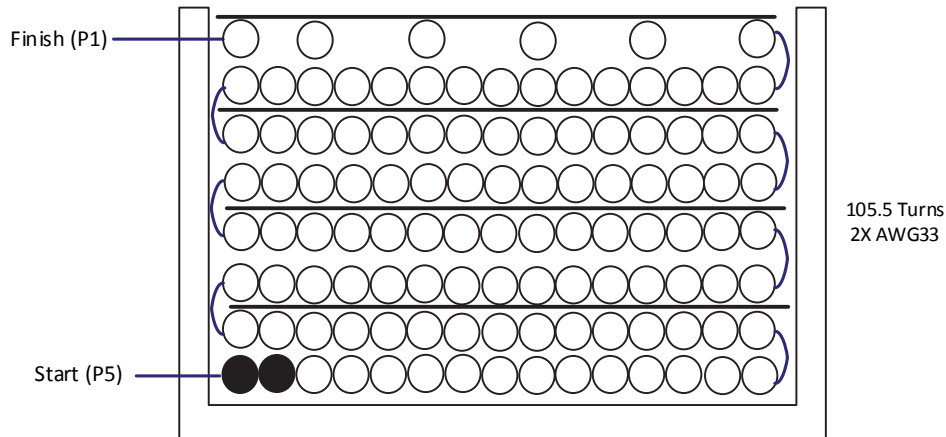

Figure 10 – Transformer Build Diagram.

8.5 Inductor Construction

Winding Directions	Bobbin is oriented on winder jig such that terminal pin 5-8 is in the left side. The winding direction is clockwise.
Winding 1	Prepare the magnetic wire Item [3] for bifilar-wound type winding. Start at pin 5 and wind 105.5 turns bifilar in 8 layers. Add 1 layer of tape Item [5] every 2 layers of magnetic wires. Finish the winding on pin 1.
Insulation	Add 1 layer of tape, Item [5]
Core Grinding	Grind the center leg of the ferrite core evenly until it meets the nominal inductance of 1200 μ H. Inductance is measured across pin 1 and pin 5.
Assemble Core	Assemble the 2 cores on the bobbin
Core Termination	Prepare a copper strip with a soldered magnetic wire (#AWG 32) at the middle as shown in the picture. Apply copper strip at the bottom part of the core and terminate the magnetic wire on pin 8.
Core Tape	Add 2 layers of tape Item [6] around the core to fix the 2 cores.
Pins	Pull out terminal pin no. 2, 3, 6 and pin 7.
Finish	Dip the transformer assembly in 2:1 varnish and thinner solution.

8.6 Inductor Winding Illustrations

Winding Directions

Bobbin is oriented on winder jig such that terminal pin 5-8 is in the left side. The winding direction is clockwise.

Winding 1

Prepare the magnetic wire Item [3] for bifilar-wound type winding. Start at pin 5 and wind 105.5 turns bifilar in 8 layers.

Add 1 layer of tape Item [5] every 2 layers of magnetic wire.

Finish the winding on pin 1.

Insulation

Add 1 layer of tape, Item [5]

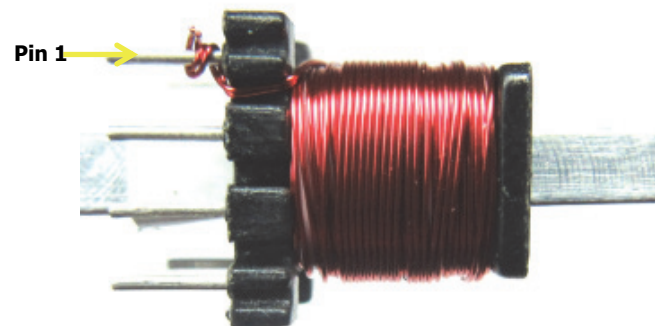
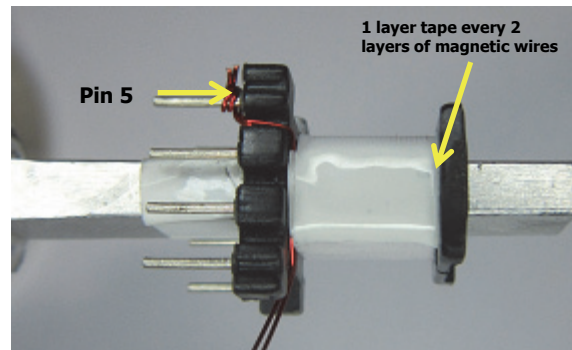
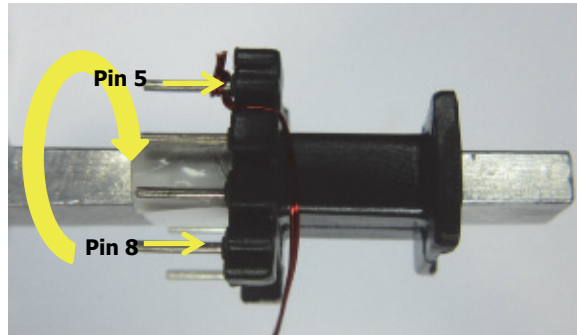

Core Termination

Prepare a copper strip with a soldered magnetic wire (AWG 32) at the middle as shown in the picture. Apply copper strip at the bottom part of the core and terminate the magnetic wire on pin 8.

Core Tape

Add 2 Layers of tape Item [6] around the core to fix the 2 cores into the bobbin.

Pins

Pull out terminal pin no. 2, 3, 6 and pin 7.

Finish

Dip the transformer assembly in 2:1 varnish and thinner solution.

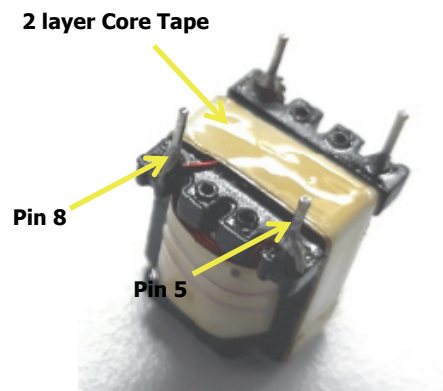
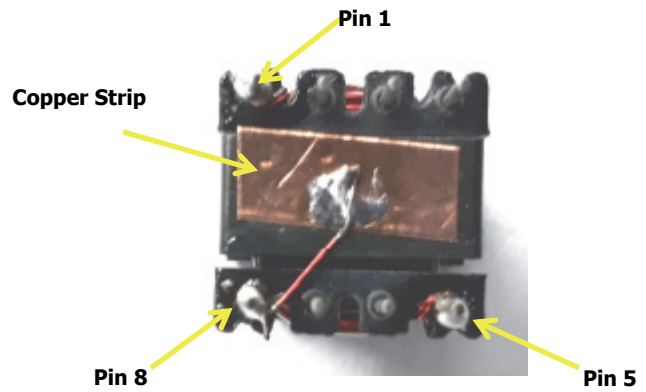

9 Design Spreadsheet

1	ACDC_Flyback_PF_LYTSwitch-6_020318; Rev.1.2; Copyright Power Integrations 2018	INPUT	INFO	OUTPUT	UNITS	Switched Valley-Fill Single Stage PFC (SVF S ² PFC)
2	Application Variables					
3	VACMIN	90		90	V	Minimum Input AC Voltage
4	VACNOM	115		115	V	Nominal AC Voltage (For universal designs low line nominal voltage is displayed)
5	VACMAX	265		265	V	Maximum Input AC Voltage
6	VACRANGE			UNIVERSAL		Input Voltage Range
7	FL	60		60	Hz	Line Frequency
8	CIN	15.0000		15.0000	μF	Minimum Input Capacitance
9	V_CIN			450	V	Input Capacitance Recommended Voltage Rating
10	VO	24.00		24.00	V	Output Voltage
11	IO	0.35		0.35	A	Output Current
12	PO			8.40	W	Total Output Power
13	N	85.00		85.00		Estimated Efficiency
14	Z			0.50		Loss Allocation Factor
15	Parametric Calculations Basis					
16	ILIMcalcBASIS	Nom		Nom		ILIM Calculations Basis - NOM,MAX or MIN only
17	PARcalcBASIS	VACNOM		VACNOM		Calculated Results Based on Selected VAC - VACNOM,VACMAX,VACMIN or Worst Case only
18	Primary Controller Section					
19	DEVICE_MODE	Standard		Standard		Device Current Limit Mode
20	DEVNAME	LYT6063C		LYT6063C		PI Device Name
21	RDSON			8.74	ohms	Device RDSON at 100degC
22	ILIMITMIN			0.511	A	Minimum Current Limit
23	ILIMITTYP			0.550	A	Typical Current Limit
24	ILIMITMAX			0.589	A	Maximum Current Limit
25	BVDSS			650	V	Drain-Source Breakdown Voltage
26	VDS			2.00	V	On state Drain to Source Voltage
27	VDRAIN			533.77	V	Peak Drain to Source Voltage during Fet turn off
28	Worst Case Electrical Parameters					
29	Boost Converter					
30	IBOOSTRMS			103.24	mA	Boost RMS current
31	IBOOSTMAX			308.29	mA	Boost PEAK current
32	IBOOSTAVG			59.10	mA	Boost AVG current
33	IIRMS			89.31	mA	Input RMS current
34	PF_est			0.8624		Estimated Power Factor
35	Flyback Converter					
36	FSMIN	48300		48300	Hz	Minimum Switching Frequency in a Line Period
37	FSMAX			100302.64	Hz	Maximum Switching Frequency in a Line Period
38	KPmin			1.3294		Minimum KP in a Line Period for VAC specified by PARcalcBASIS
39	IFETRMS			157.72	mA	Fet RMS current
40	IFETMAX			550.34	mA	Fet PEAK current
41	IPRIRMS			0.1207	A	Primary Winding RMS current
42	IPRIMAX			0.4930	A	Primary Winding PEAK current
43	IPRIAVG			0.0210	A	Primary Winding AVG current
44	IPRIMIN			236.41	mA	Primary Winding Minimum current
45	ISECRMS			0.63	A	Secondary RMS current
46	ISECMAX			1.88	A	Secondary PEAK current
47	Boost Choke Construction Parameters					



48	RATIO_LBST_LFB	0.7740		0.7740		Boost Inductance and Flyback Primary Inductance Ratio
49	LBOOSTMIN			1141.15	μH	Minimum Boost Inductance
50	LBOOSTNOM			1201.21	μH	Nominal Boost Inductance
51	LBOOSTMAX			1261.27	μH	Maximum Boost Inductance
52	LBOOSTTOL	5.00		5.00	%	Boost Inductance Tolerance
53	Boost Core and Bobbin Selection					
54	CR_TYPE_BOOST	EE10		EE10		Boost Core
55	CR_PN_BOOST			PC40EE10/11-Z		Boost Core Code
56	AE_BOOST			12.10	mm^2	Boost Core Cross Sectional Area
57	LE_BOOST			26.10	mm	Boost Core Magnetic Path Length
58	AL_BOOST			850.00	nH/turns^2	Boost Core Ungapped Core Effective Inductance
59	VE_BOOST			315.00	mm^3	Boost Core Volume
60	BOBBINID_BOOST			BE10-118CPSFR		Bobbin
61	AW_BOOST			12.20	mm^2	Window Area of Bobbin
62	BW_BOOST			6.60	mm	Bobbin Width
63	MARGIN_BOOST			0.00	mm	Safety Margin Width
64	BOBFILLFACTOR_Boost			41.67	%	Boost Bobbin Fill Factor
65	Boost Winding Details					
66	NBOOST	105.50		105.50		Boost Choke Turns
67	BP_BOOST			3050.59	Gauss	Boost Peak Flux Density
68	ALG_BOOST			107.92	nH/turns^2	Boost Core Ungapped Core Effective Inductance
69	LG_BOOST			0.12	mm	Boost Core Gap Length
70	L_BOOST	3.50		3.50		Number of Boost Layers
71	AWG_BOOST			33.00		Boost Winding Wire AWG
72	OD_BOOST_INSULATED			0.22	mm	Boost Winding Wire Output Diameter with Insulation
73	OD_BOOST_BARE			0.18	mm	Boost Winding Wire Output Diameter without Insulation
74	CMA_BOOST			450.82	Circular Mils/A	Boost Winding Wire CMA
75	Flyback Transformer Construction Parameters					
76	VOR	89		89	V	Secondary Voltage Reflected in the Primary Winding
77	LP_MIN			1474.36	μH	Minimum Flyback Inductance
78	LP_NOM			1551.95	μH	Nominal Flyback Inductance
79	LP_MAX			1629.55	μH	Maximum Flyback Inductance
80	LP_TOL	5.00		5.00	%	Flyback Inductance Tolerance
81	Flyback Core and Bobbin Selection					
82	CR_TYPE	Custom		Custom		Flyback Core
83	CR_PN			Custom		Flyback Core Code
84	AE	33.77		33.77	mm^2	Flyback Core Cross Sectional Area
85	LE	29.00		29.00	mm	Flyback Core Magnetic Path Length
86	AL	2600.00		2600.00	nH/turns^2	Flyback Core Ungapped Core Effective Inductance
87	VE	980.00		980.00	mm^3	Flyback Core Volume
88	BOBBINID	EE1621		EE1621		Flyback Bobbin
89	BB_ORIENTATION			H		Flyback Bobbin Orientation H -Horizontal and V -Vertical
90	AW	15.00		15.00	mm^2	Flyback Window Area of Bobbin
91	BW	5.00		5.00	mm	Flyback Bobbin Width
92	MARGIN			0.00	mm	Safety Margin Width
93	Flyback Winding Details					
94	NP			67.00		Primary Turns
95	BP			4341.85	Gauss	Flyback Peak Flux Density
96	BM			4236.28	Gauss	Flyback Maximum Flux Density

97	BAC			1690.64	Gauss	Flyback AC Flux Density
98	ALG			345.72	nH/turns ²	Flyback Core Ungapped Core Effective Inductance
99	LG			0.11	mm	Flyback Core Gap Length
100	L	3.00		3.00		Number of Flyback Layers
101	AWG			32.00		Primary Winding Wire AWG
102	OD			0.24	mm	Primary Winding Wire Output Diameter with Insulation
103	DIA			0.20	mm	Primary Winding Wire Output Diameter without Insulation
104	CMA			481.74	Circular Mils/A	Primary Winding Wire CMA
105	NB			10.00		Bias Turns
106	L_BIAS	2.00		2.00		Number of Flyback Bias Winding Layers
107	AWGpBias			36.00		Bias Wire AWG
108	NS	18		18		Secondary Turns
109	AWGS			29.00		Secondary Winding Wire AWG
110	ODS			0.29	mm	Secondary Winding Wire Output Diameter with Insulation
111	DIAS			0.59	mm	Secondary Winding Wire Output Diameter without Insulation
112	CMAS			201.30	Circular Mils/A	Secondary Winding Wire CMA
113	Primary Components Selection					
114	Line Undervoltage					
115	BROWN_IN_REQUIRE D	88.00		88.00	V	Required AC RMS line voltage brown-in threshold
116	RLS			2.21	MOhm	Two Resistors of this Value in Series to the V-pin
117	BROWN_IN_ACTUAL			88.53	V	Actual AC RMS brown-in threshold
118	Line Overvoltage					
119	OVERVOLTAGE_LINE			369.26	V	Actual AC RMS line over-voltage threshold
120	Bias Voltage					
121	VBIAS			12.0	V	Rectified Bias Voltage
122	VF_BIASDIODE			0.70	V	Bias Winding Diode Forward Drop
123	VRRM_BIASDIODE			67.94	V	Bias diode reverse voltage
124	CBIAS			22.0	µF	Bias winding rectification capacitor
125	CBPP			0.47	µF	BPP pin capacitor
126	Bulk Capacitor Zener Clamp					
127	Use_Clamp			Yes		Bulk Capacitor Clamp Needed? Yes, No or N/A
128	VZ1_V			200.00	V	Zener 1 Voltage Rating (In Series with Zener 2)
129	PZ1_W			0.80	W	Zener 1 Minimum Power Rating
130	VZ2_V			200.00	V	Zener 2 Voltage Rating
131	PZ2_W			0.80	W	Zener 2 Minimum Power Rating
132	RZ			4700.00	ohms	Resistor in series with Zener 1 and Zener 2
133	Secondary Components Selection					
134	Feedback Components					
135	RFB_UPPER			102.00	kOhm	Upper feedback 1% resistor
136	RFB_LOWER			5.60	kOhm	Lower feedback 1% resistor
137	CFB_LOWER			330.0	pF	Lower feedback resistor decoupling at least 5V-rating capacitor
138	CBPS			2.2	µF	BPS pin capacitor
139	Secondary Auxiliary Section - For VO > 24V ONLY					
140	Sec Aux Diode					
141	VAUX			12.00	V	Rectified auxiliary voltage
142	VF_AUX			0.70	V	Auxiliary winding diode forward drop
143	VRRM_AUXDIODE			67.94	V	Auxiliary diode reverse voltage
144	CAUX			22.00	µF	Auxiliary winding rectification capacitor
145	NAUX_SEC			10.00		Secondary Aux Turns
146	L_AUX			1.00		Number of Flyback Aux Winding Layers



147	AWGSAUX			38		Secondary Aux Winding AWG
148	Output Parameters					
149	VOUT_ACTUAL			24.00	V	Actual Output Voltage
150	IOUT_ACTUAL			0.35	A	Actual Output Current
151	ISECRMS			0.63	A	Secondary RMS current for output
152	Output Components					
153	VF			0.70	V	Output diode forward drop
154	VRRM			124.68	V	Output diode reverse voltage
155	COUT			120.77	μF	Output Capacitor - Capacitance
156	COUT_VOpercentRip			2.50	%	Output Capacitor Ripple % of VOUT
157	ICOUTrms			0.52	A	Output Capacitor Estimated Ripple Current
158	ESRmax			318.78	mohms	Output Capacitor Maximum Recommended ESR
159	Errors, Warnings, Information					
160	Information					Although the design has passed the user should validate functionality on the bench. Please check the variables listed.
161	Design Warnings			BP,BM,OVERV OLTAGE_LINE		Design variables whose values exceed electrical/datasheet specifications.
162	Design Errors					The list of design variables which result in an infeasible design.

Notes: Row 161 – no saturation observed on DCDC transformer during start-up, normal, and start-up output short-circuit operation at high temperature (at 100-110 °C core temperature). Actual line overvoltage protection is below the absolute maximum V_{DS} rating of LYTSwitch-6 IC.

10 Performance Data

All measurements were performed at room temperature.

10.1 CV/CC Output Characteristic Curve

Set-up: Open frame unit.
Load: E-load set in CR mode, 68.57 Ω, full load with 1% resistance load change.
Ambient Temperature: 25 °C.
Soak Time: 20 seconds per every loading point.

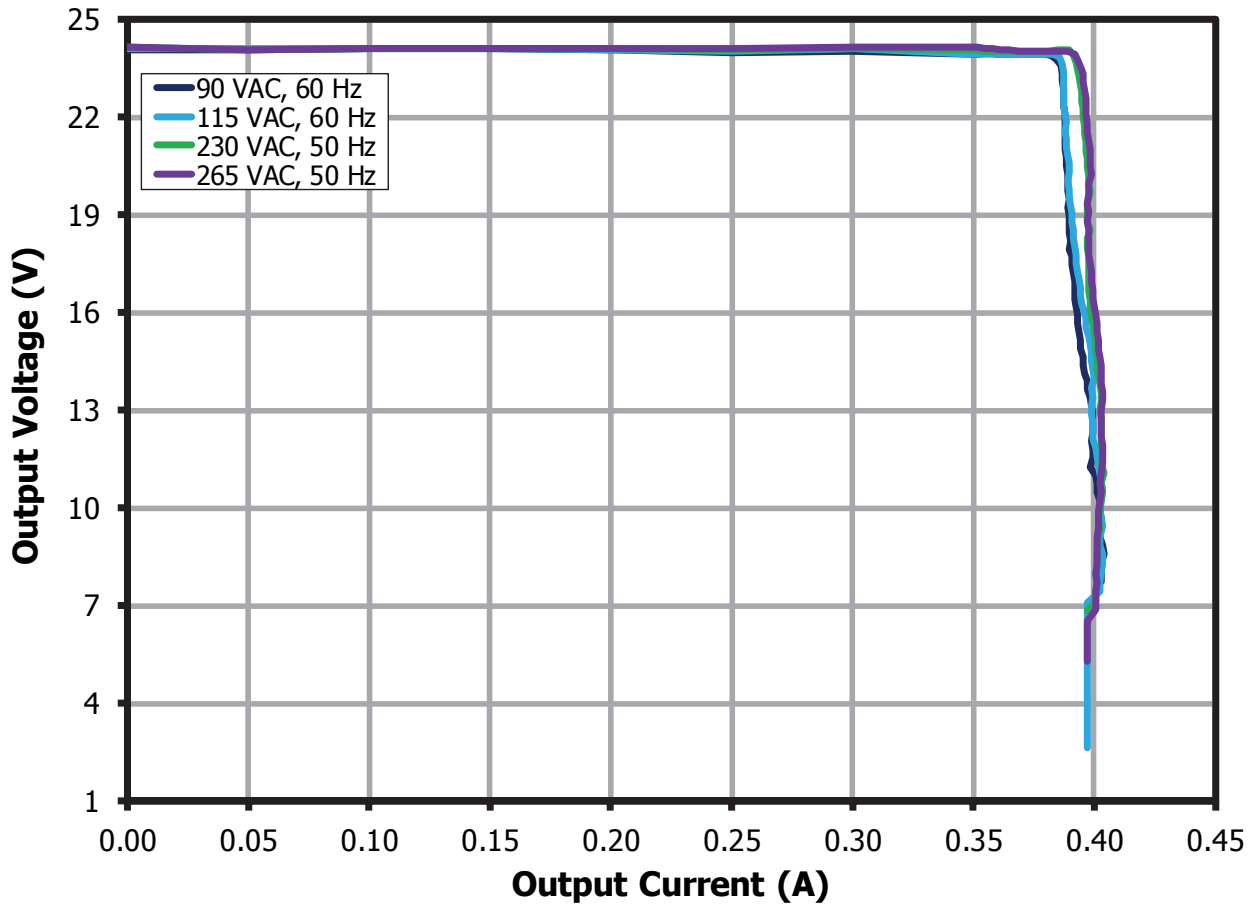

Figure 11 – CV/CC Curve.

10.2 System Efficiency

Set-up: Open frame unit.
Load: 350 mA CC load.
Ambient Temperature: 25 °C.
Soak Time: 60 seconds per input line.

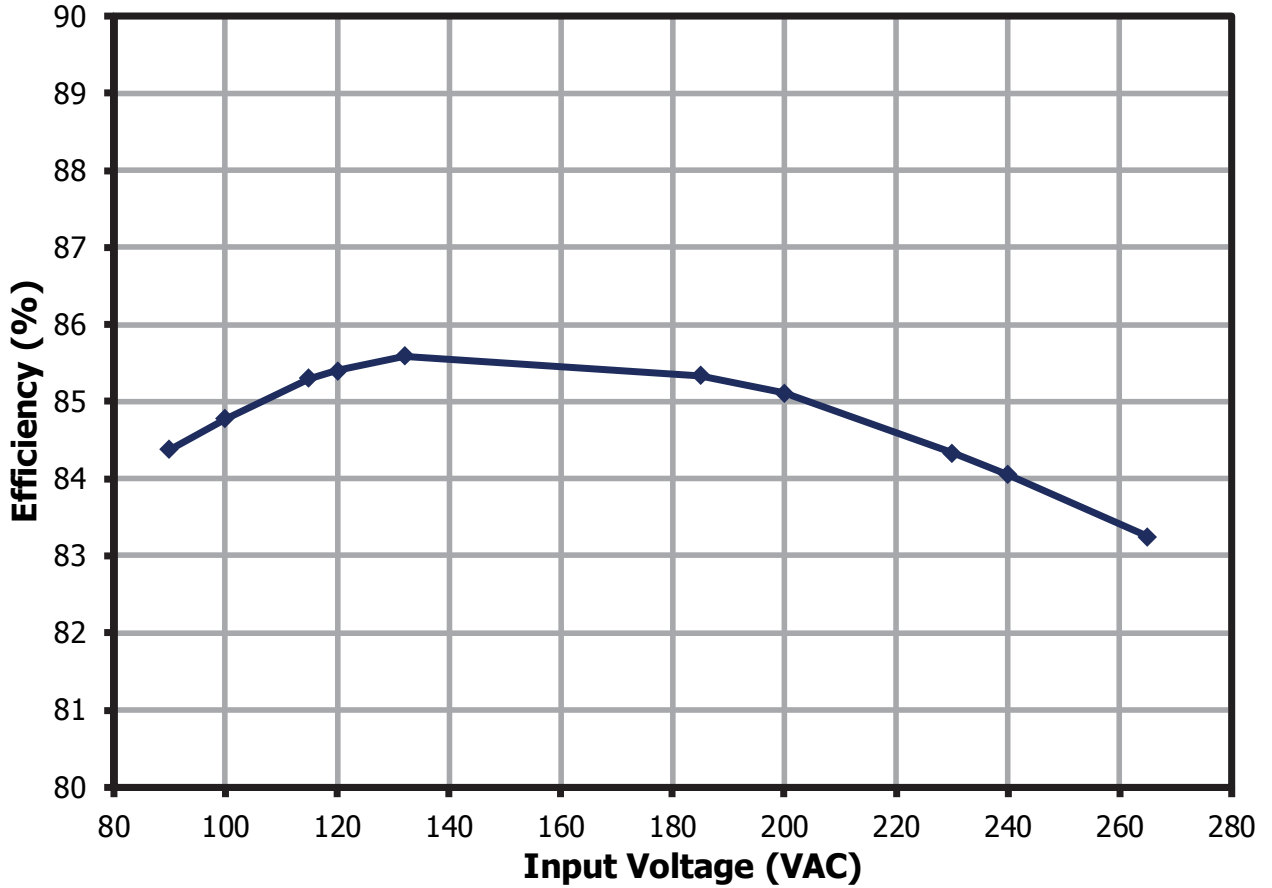

Figure 12 – Efficiency vs. Line.



10.3 Output Voltage Regulation

Set-up: Open frame unit.
Load: 350 mA CC load.
Ambient Temperature: 25 °C.
Soak Time: 60 seconds per input line.

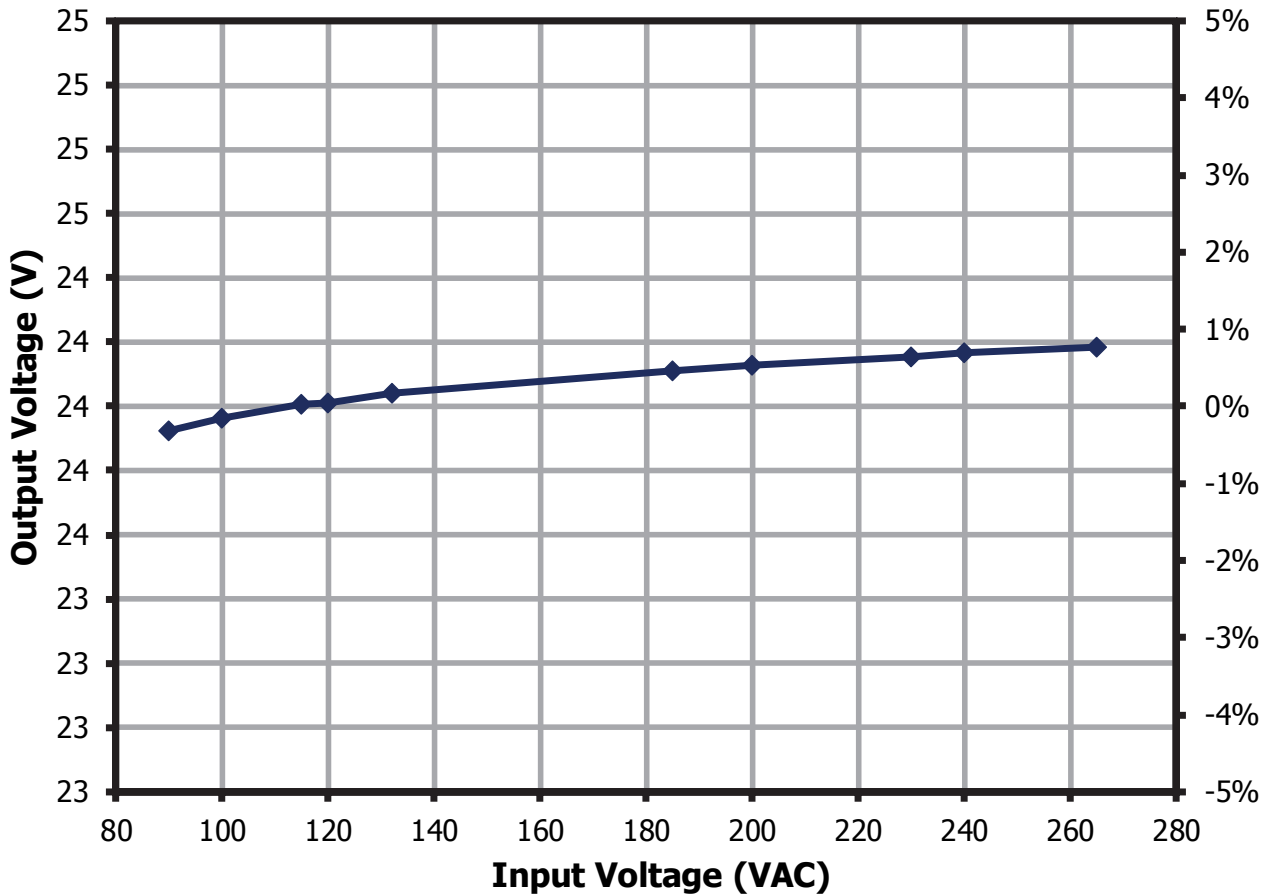

Figure 13 – Output Voltage Regulation vs. Line.

10.4 Power Factor

Set-up: Open frame unit.
Load: 350 mA CC load.
Ambient Temperature: 25 °C.
Soak Time: 60 seconds per input line.

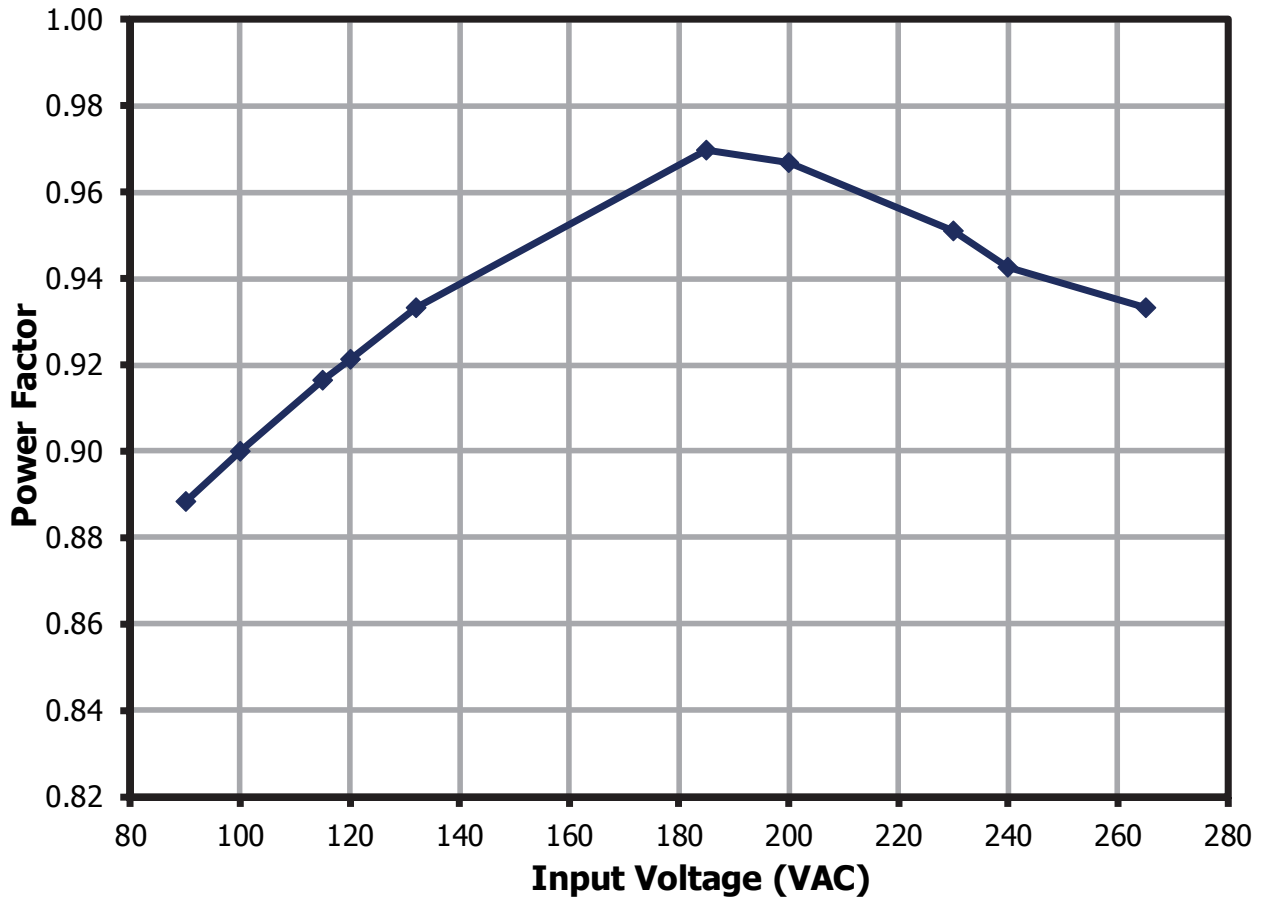

Figure 14 – Power Factor vs. Line.



10.5 %ATHD

Set-up: Open frame unit.
Load: 350 mA CC load.
Ambient Temperature: 25 °C.
Soak Time: 60 seconds per input line.

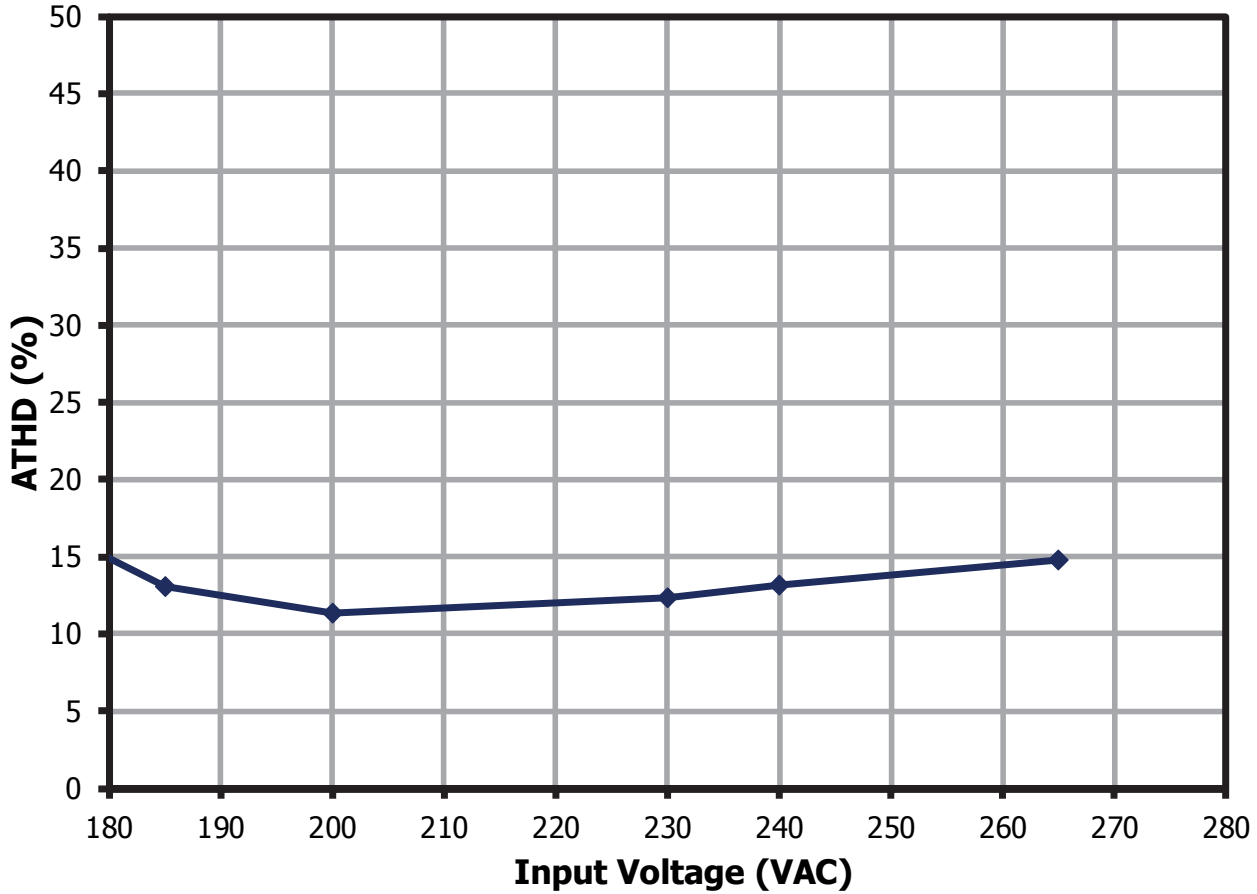

Figure 15 – %ATHD vs. Line.

10.6 Individual Harmonics Content at Full Load

Set-up: Open frame unit.
Load: 350 mA CC load.
VIN: 230 V 50 Hz.
Ambient Temperature: 25 °C.
Soak Time: 60 seconds.

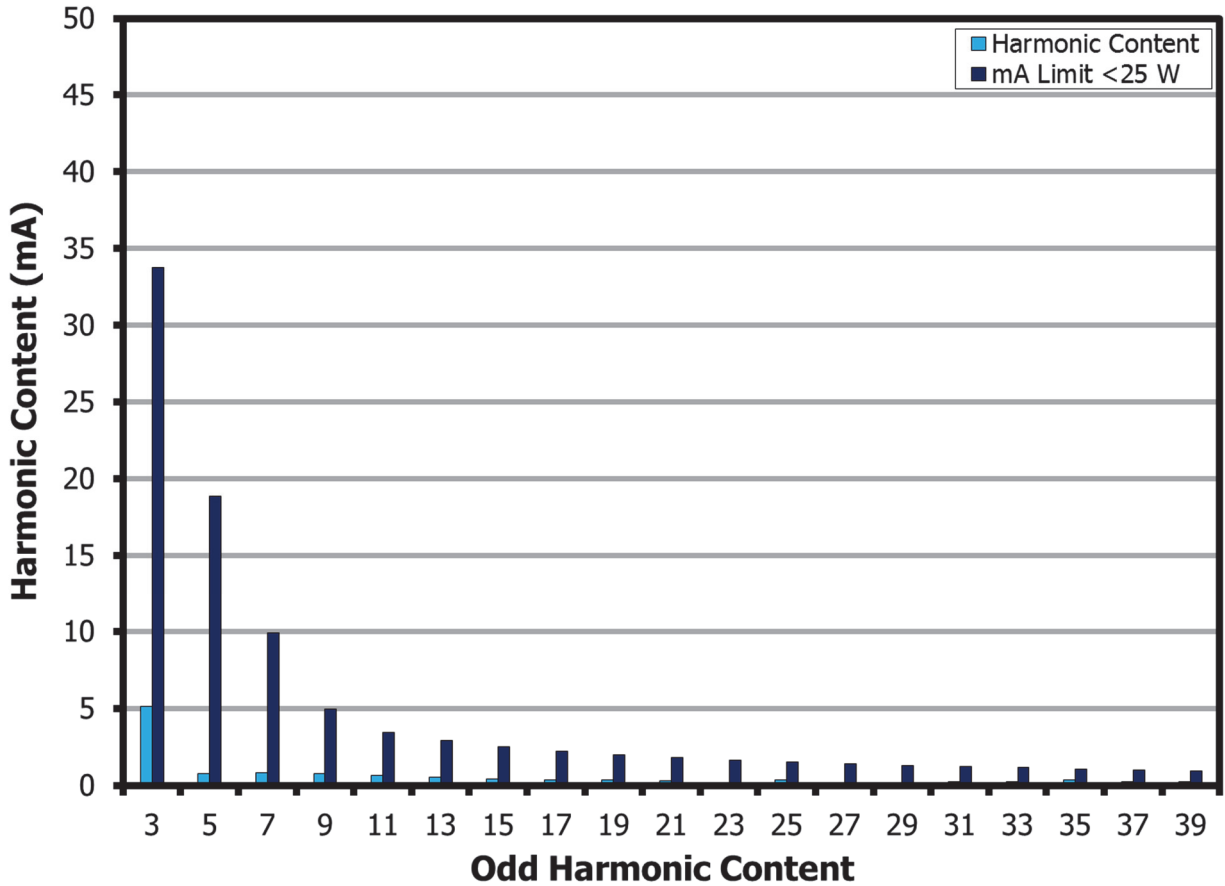

Figure 16 – Full Load Input Current Harmonics at 230 VAC 50 Hz.



10.7 No-Load Input Power

Set-up: Open frame unit.
Load: No-load.
Ambient Temperature: 25 °C.
Soak Time: 60 seconds per line.

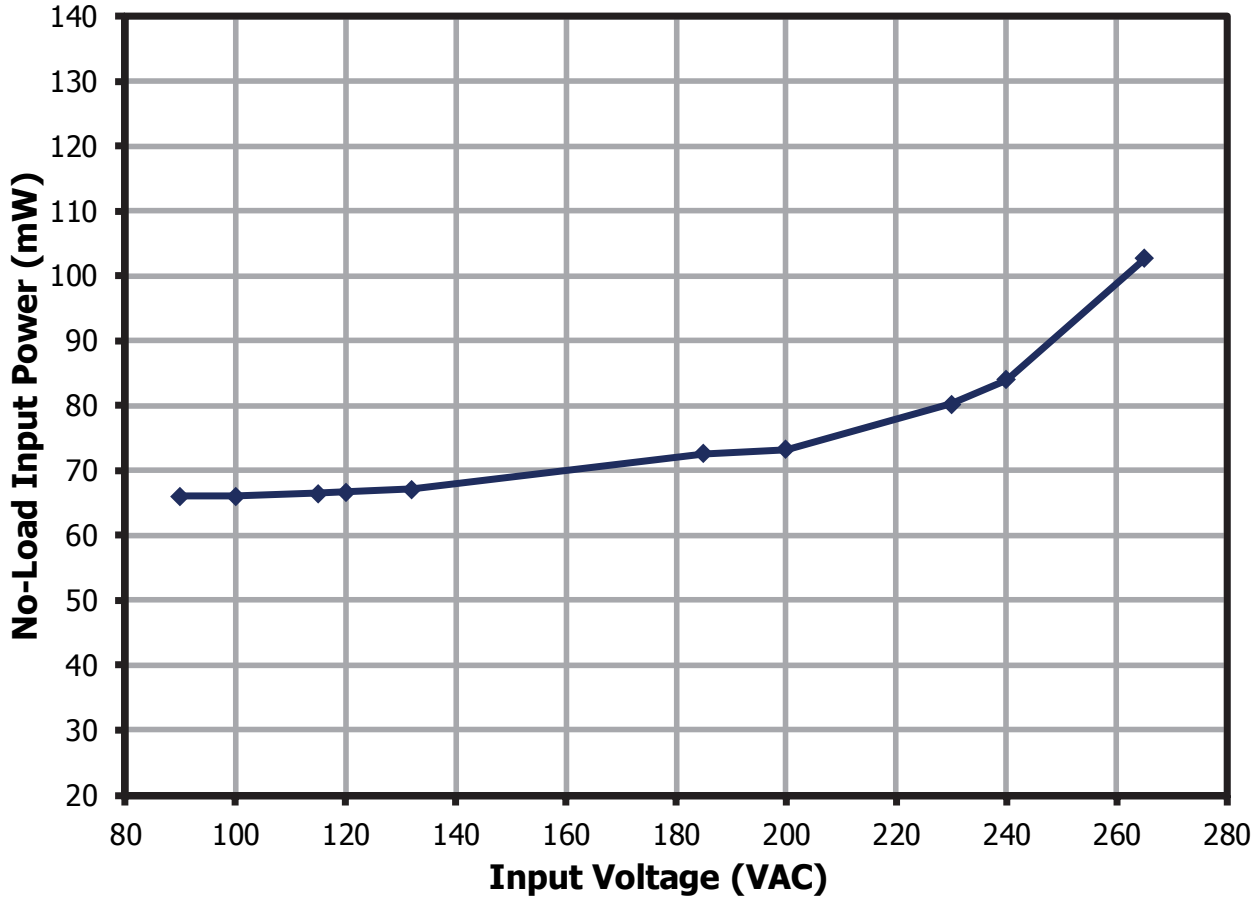

Figure 17 – No Load Input Power vs. Line.

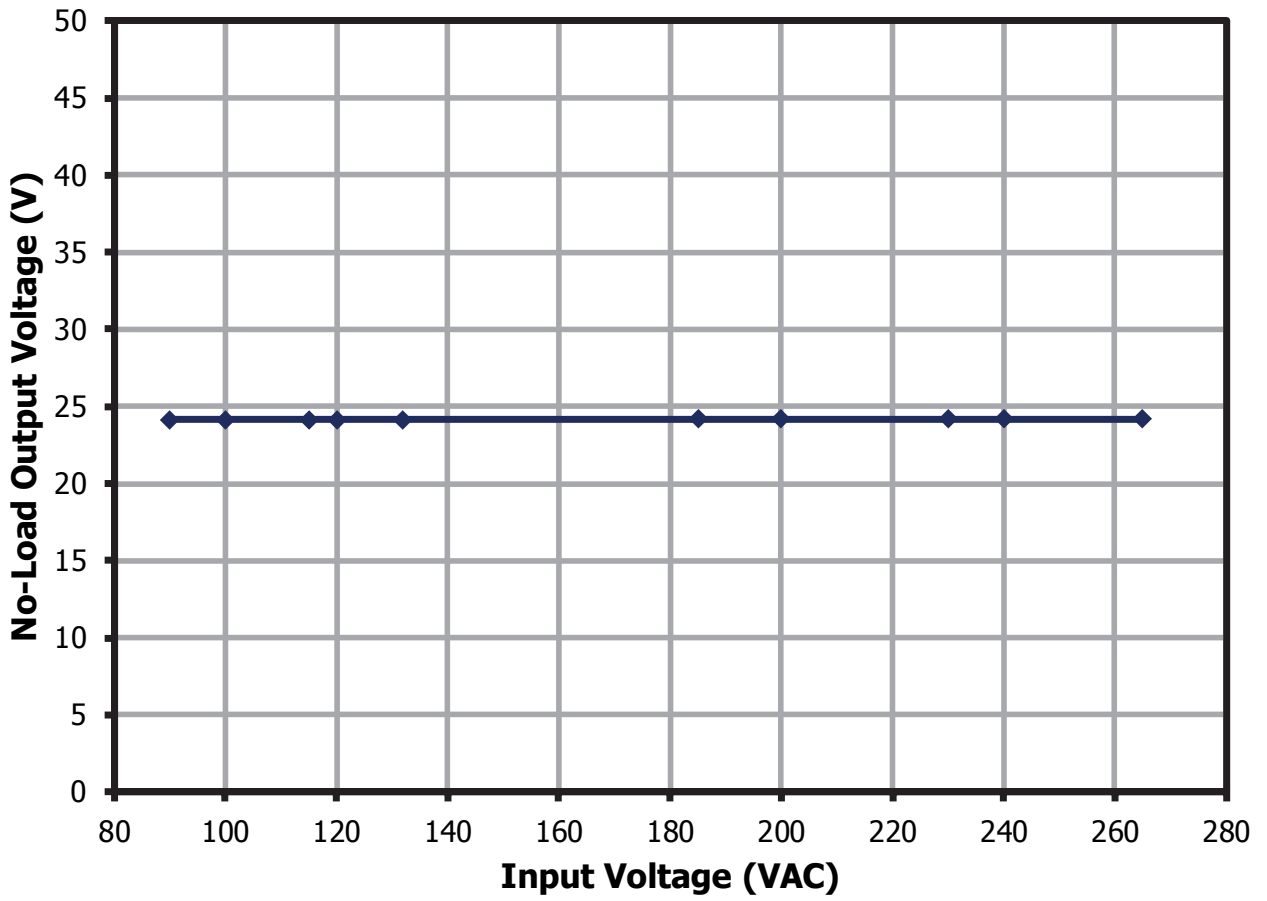

Figure 18 – No-Load Voltage vs. Line.



11 Test Data

11.1 Test Data at Full Load

Input		Input Measurement					LED Load Measurement			Efficiency (%)
VAC (V _{RMS})	Freq (Hz)	V _{IN} (V _{RMS})	I _{IN} (mA _{RMS})	P _{IN} (W)	PF	%ATHD	V _{OUT} (V _{DC})	I _{OUT} (mA _{DC})	P _{OUT} (W)	
90	60	89.93	0.12	9.91	0.889	43.25	23.92	0.35	8.36	84.38
100	60	99.89	0.11	9.87	0.900	41.15	23.96	0.35	8.37	84.77
115	60	114.92	0.09	9.83	0.917	37.06	24.01	0.35	8.39	85.30
120	60	119.89	0.09	9.82	0.921	35.77	24.01	0.35	8.39	85.40
132	60	131.90	0.08	9.81	0.933	32.42	24.04	0.35	8.40	85.59
185	50	184.90	0.06	9.87	0.970	13.07	24.11	0.35	8.43	85.34
200	50	199.92	0.05	9.91	0.967	11.33	24.13	0.35	8.43	85.11
230	50	229.93	0.05	10.01	0.951	12.31	24.15	0.35	8.44	84.34
240	50	239.97	0.04	10.04	0.943	13.13	24.16	0.35	8.44	84.05
265	50	264.95	0.04	10.15	0.933	14.83	24.19	0.35	8.45	83.25

11.2 Test Data at No-Load

Input		Input Measurement			V _{OUT} (V _{DC})
VAC (V _{RMS})	Freq (Hz)	V _{IN} (V _{RMS})	I _{IN} (mA _{RMS})	P _{IN} (W)	
90	60	90.01	4.92	69.90	24.23
100	60	99.96	4.93	75.80	24.24
115	60	114.97	4.96	79.00	24.24
120	60	119.95	4.99	72.60	24.24
132	60	131.95	5.05	77.00	24.24
185	50	184.94	5.29	101.90	24.24
200	50	199.95	5.45	89.80	24.24
230	50	229.97	5.73	86.90	24.25
240	50	240.00	5.83	90.40	24.25
265	50	264.98	6.22	110.10	24.25

11.3 Individual Harmonic Content at 230 VAC 50 Hz and Full Load

V_{IN} (V_{RMS})	Freq	I_{IN} (mA_{RMS})	P_{IN} (W)	%THD
230	50	45.59	9.94	12.52
Harmonic Content			mA Limit <25W	
nth Order	mA Content	% Content	mA Limit <25 W	Remarks
1	44.49			
2	0.09	0.20%		
3	5.17	11.62%	33.79	Pass
5	0.76	1.71%	18.88	Pass
7	0.82	1.84%	9.94	Pass
9	0.78	1.75%	4.97	Pass
11	0.67	1.51%	3.48	Pass
13	0.56	1.26%	2.94	Pass
15	0.44	0.99%	2.55	Pass
17	0.39	0.88%	2.25	Pass
19	0.36	0.81%	2.01	Pass
21	0.29	0.65%	1.82	Pass
23	0.20	0.45%	1.66	Pass
25	0.37	0.83%	1.53	Pass
27	0.13	0.29%	1.42	Pass
29	0.20	0.45%	1.32	Pass
31	0.24	0.54%	1.23	Pass
33	0.26	0.58%	1.16	Pass
35	0.38	0.85%	1.09	Pass
37	0.23	0.52%	1.03	Pass
39	0.23	0.52%	0.98	Pass

12 Load Regulation Performance

Set-up: Open frame unit.
Ambient Temperature: 25 °C.
Soak Time: 30 seconds per loading point.

12.1 Output Voltage Load Regulation

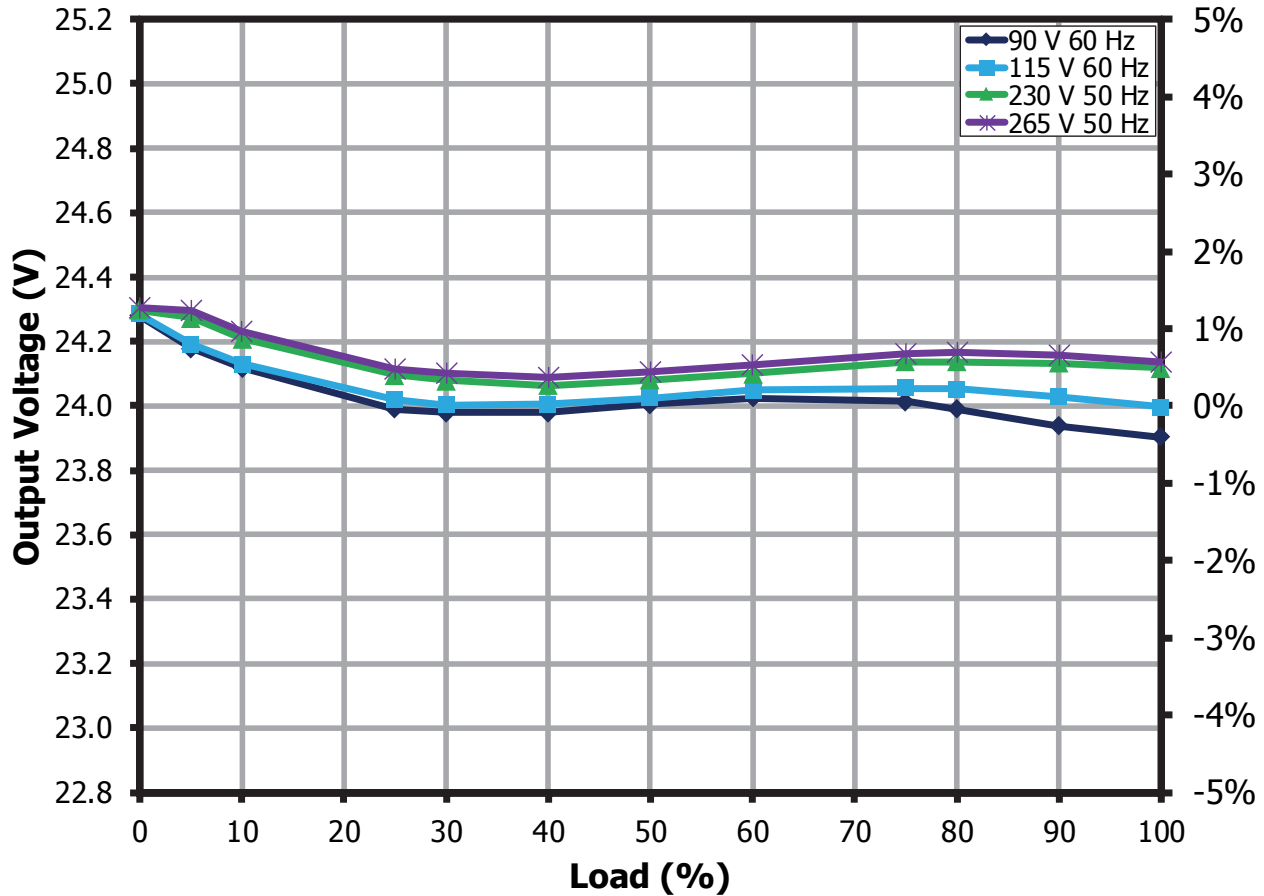

Figure 19 – Output Voltage vs. Load.

12.2 Efficiency vs. Load

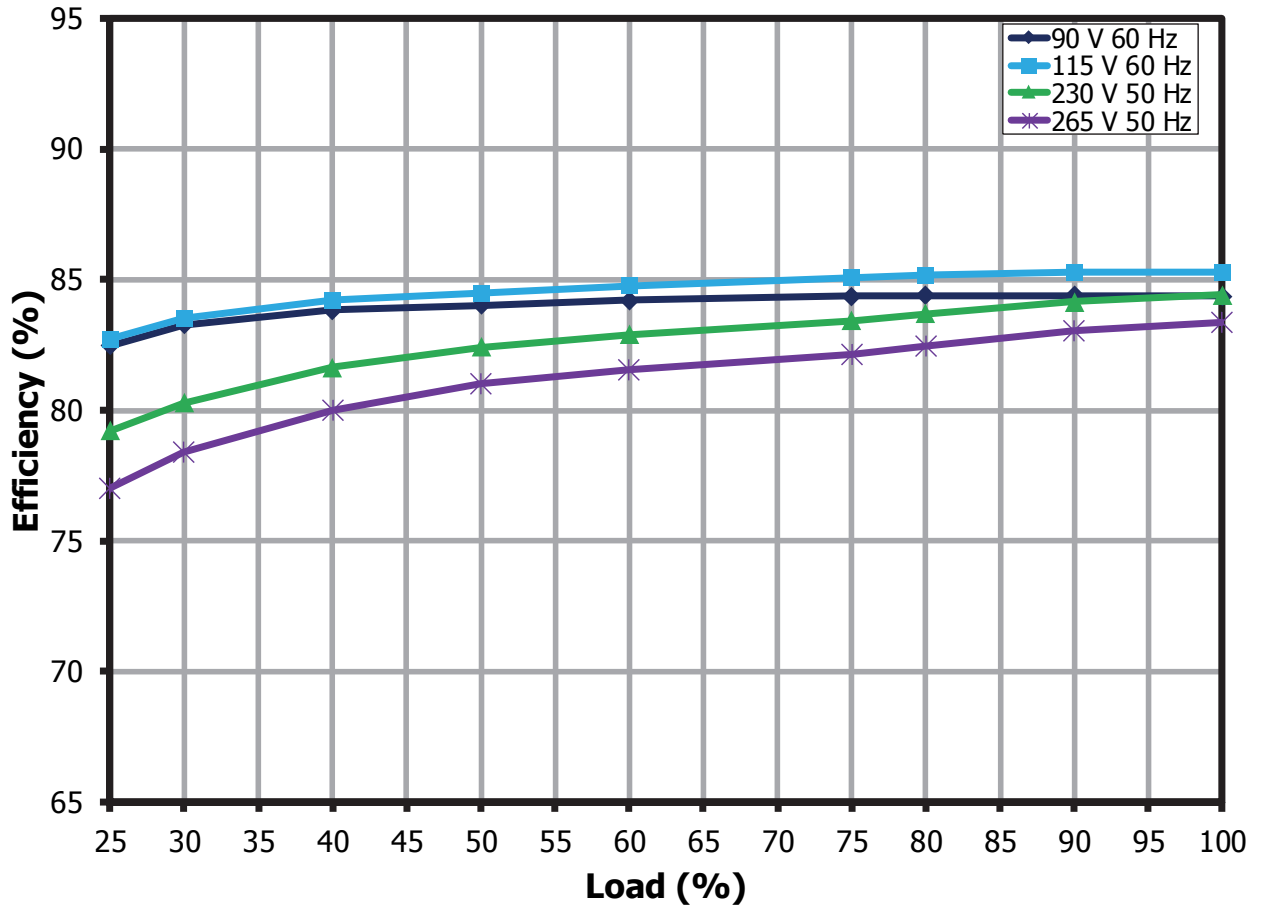

Figure 20 – Efficiency vs Load.

12.3 Average Efficiency

12.3.1.1 Average Efficiency Measurement

% Load	Efficiency %	
	115 V / 60 Hz	230 V / 50 Hz
100%	85.28	84.43
75%	85.09	83.43
50%	84.47	82.42
25%	82.71	79.21
AVERAGE EFFICIENCY	84.39	82.37
DOE LEVEL VI Limit	80.93	

Note: DOE Level VI Limit for Single-Voltage External Ac-Dc Power Supply, Basic-Voltage Efficiency Limit $\geq 0.071 \times \ln(P_{out}) - 0.0014 \times P_{out} + 0.67$



12.4 Power Factor vs. Load

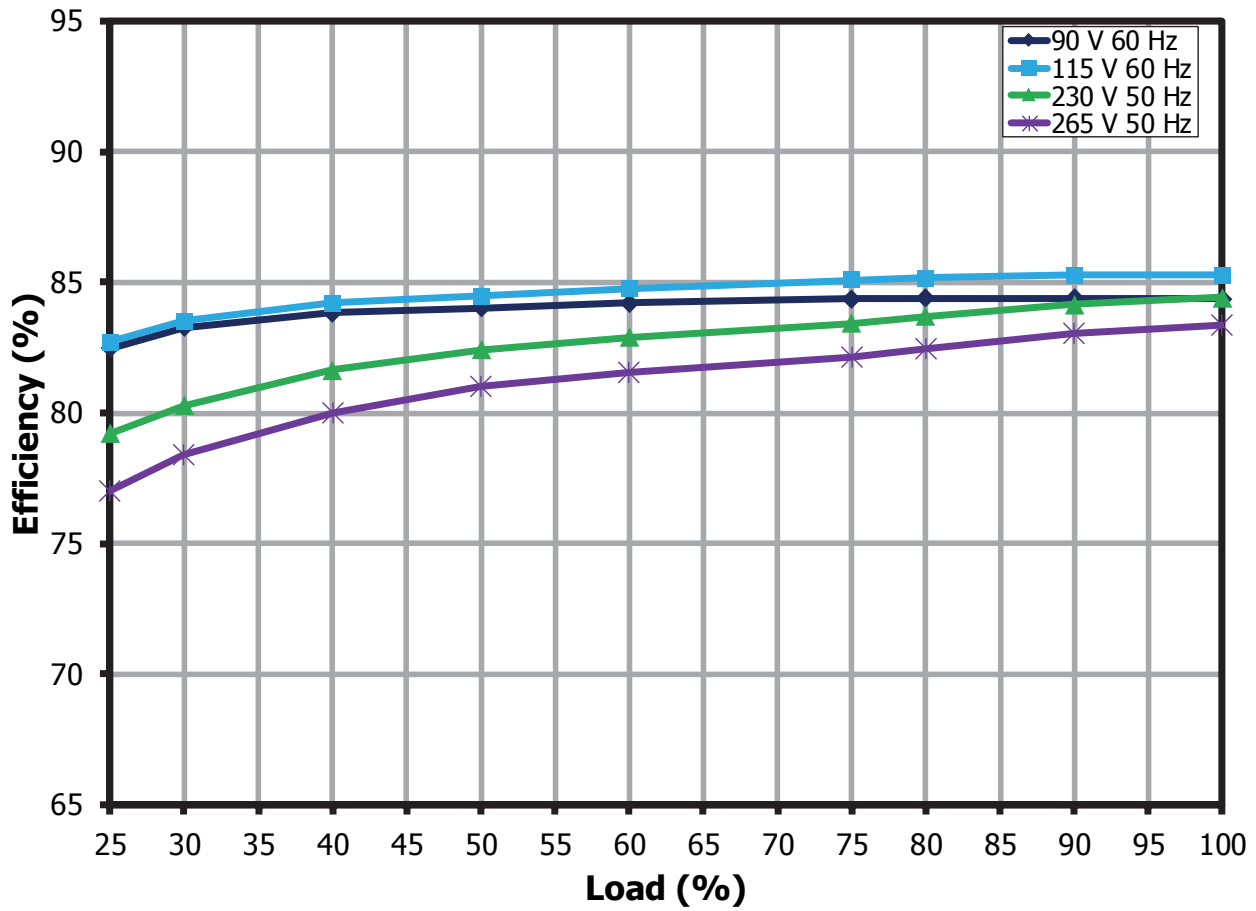

Figure 21 – Power Factor vs. Load.

12.5 % ATHD vs. Load

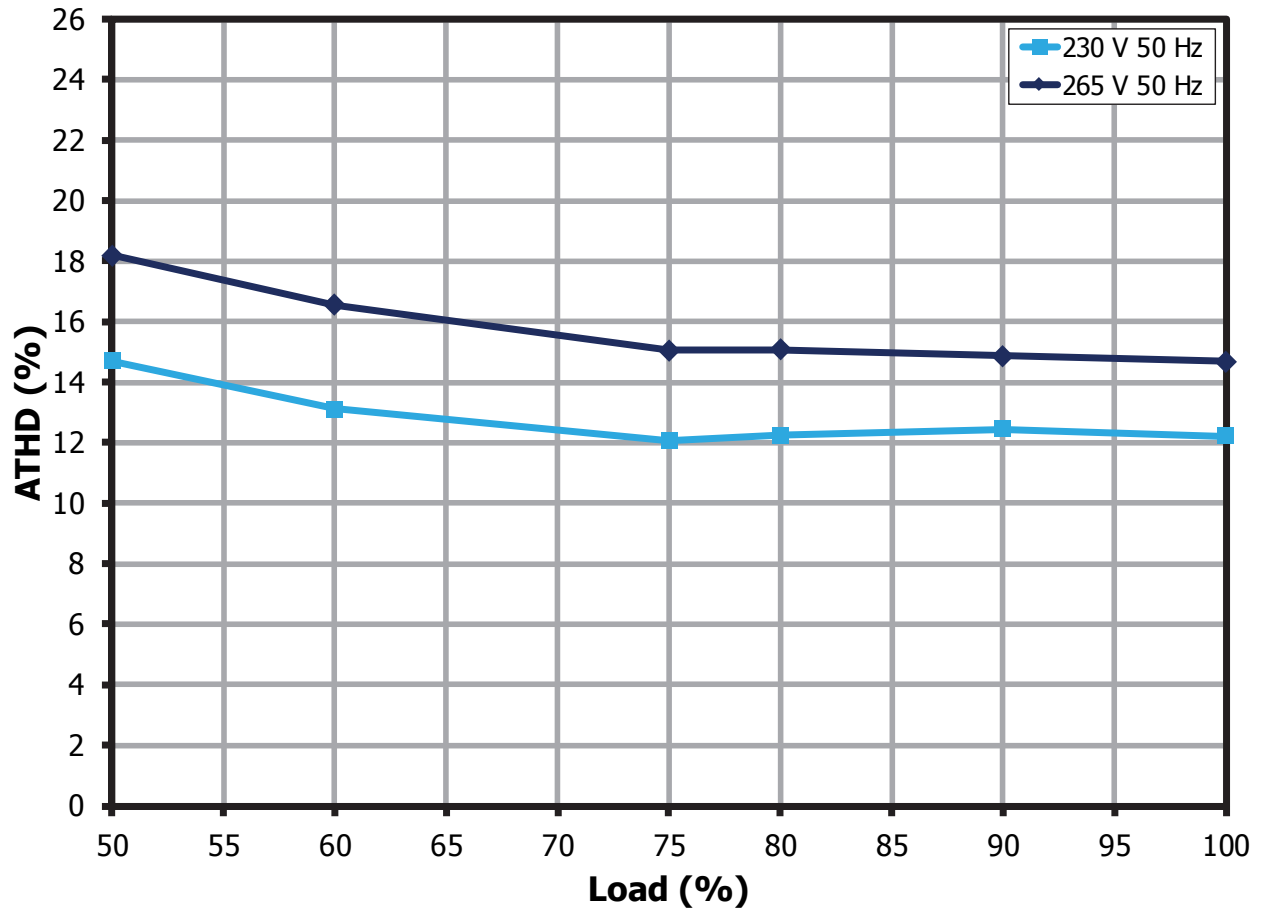

Figure 22 – Power Factor vs Load.



13 Thermal Performance

13.1 Thermal Scan at 25 °C Ambient

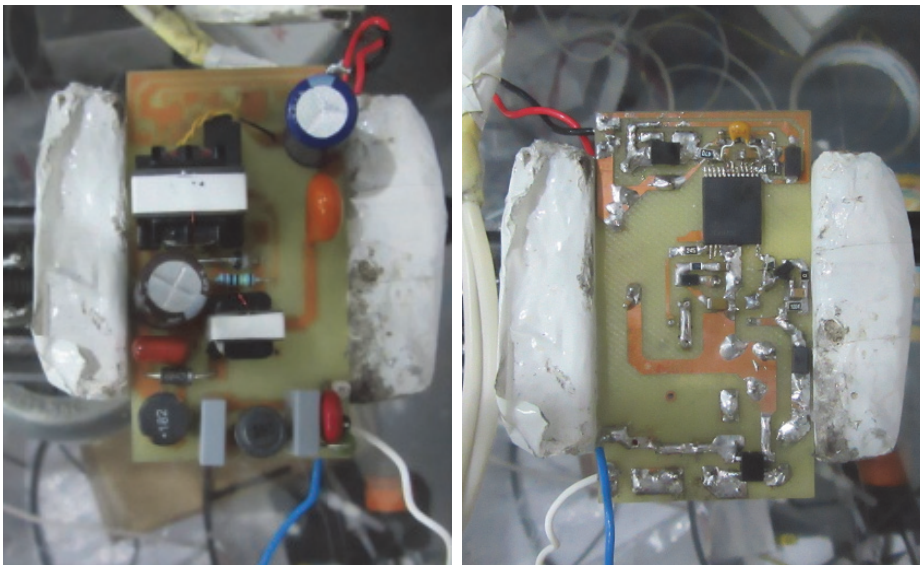
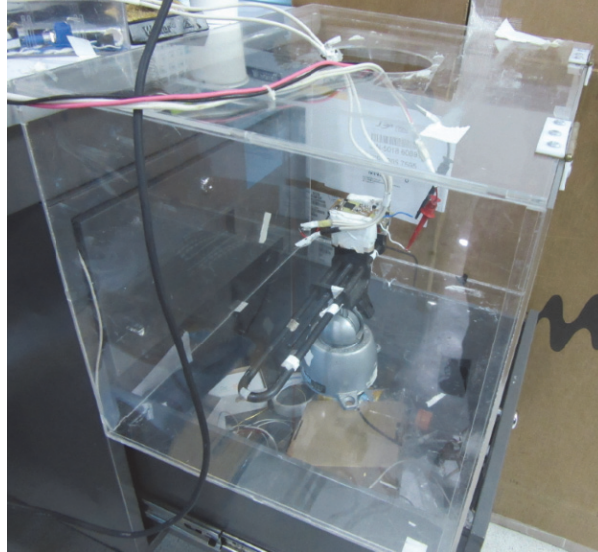

Figure 23 – Test Set-up Picture - Open Frame.

Unit in open frame was placed inside the acrylic enclosure to prevent airflow that might affect the thermal measurements. Temperature was measured using FLIR thermal camera.

13.1.1 Thermal Scan at 90 VAC Full Load

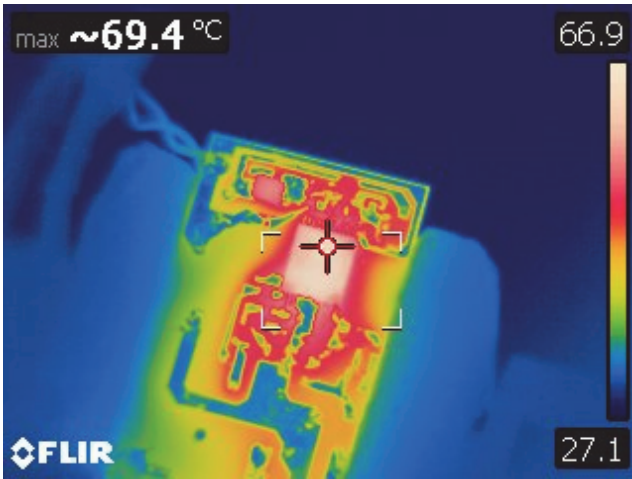

Figure 24 – 90 VAC 60 Hz, Full Load.
LYTSwitch-6 (U1): 69.4 °C.

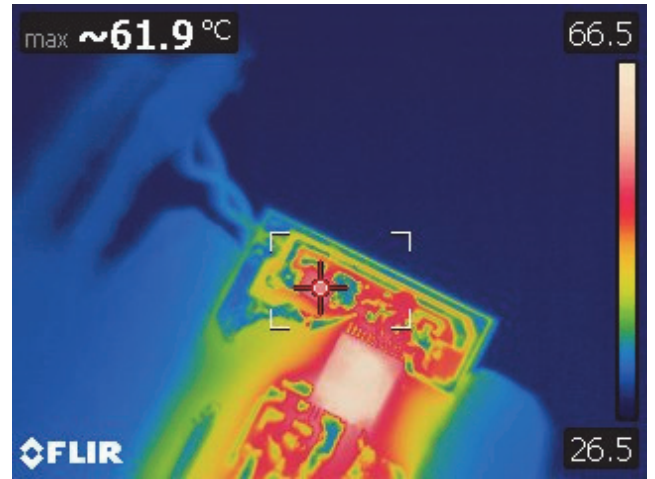

Figure 25 – 90 VAC 60 Hz, Full Load.
Output Diode (D6): 61.9 °C.

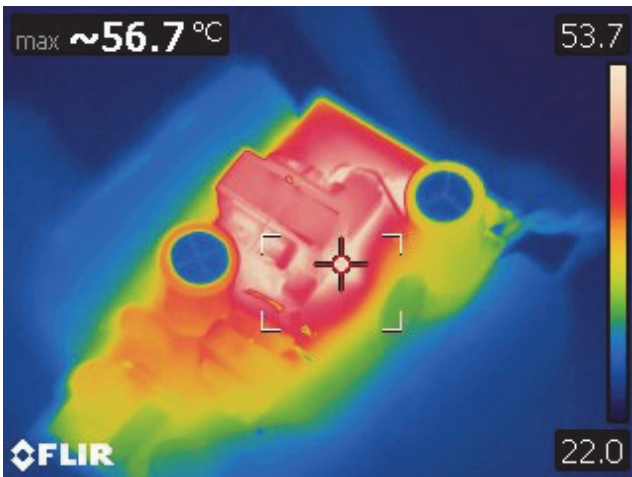

Figure 26 – 90 VAC 60 Hz, Full Load.
Power Transformer (T1): 56.7 °C.

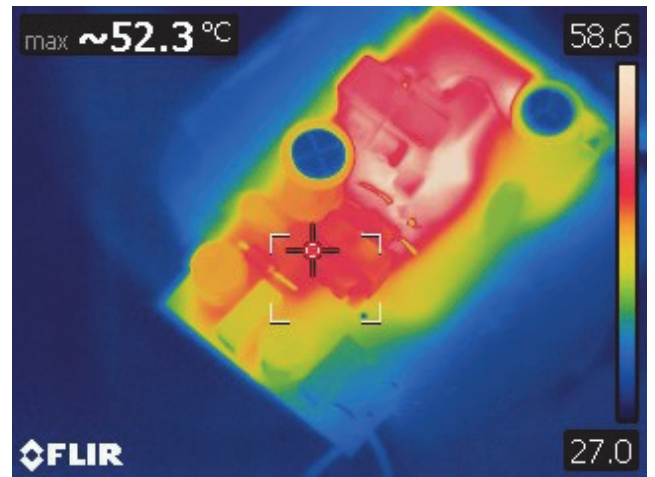

Figure 27 – 90 VAC 60 Hz, Full Load.
PFC Inductor: 52.3 °C.

13.1.2 Thermal Scan at 115 VAC Full Load



Figure 28 – 115 VAC 60 Hz, Full Load.
LYTSwitch-6 (U1): 67.3 °C.

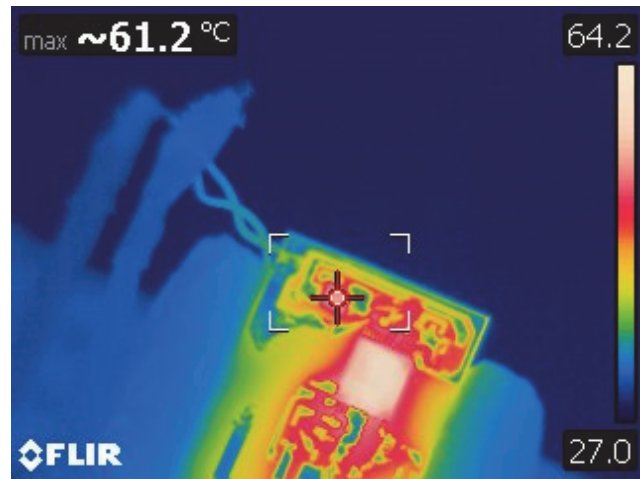

Figure 29 – 115 VAC 60 Hz, Full Load.
Output Diode (D6): 61.2 °C.

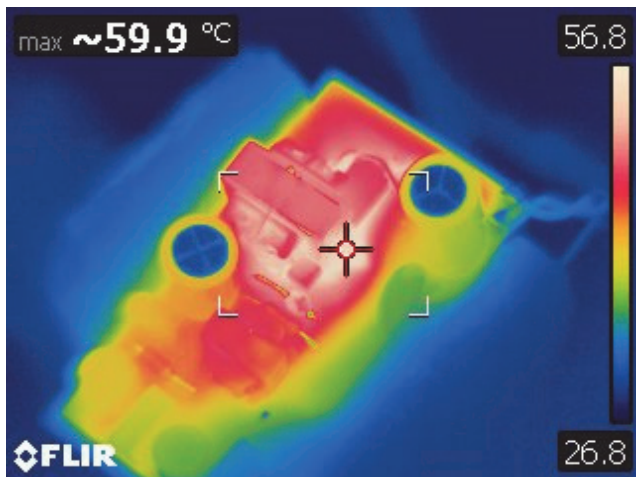

Figure 30 – 115 VAC 60 Hz, Full Load.
Power Transformer (T1): 59.9 °C.

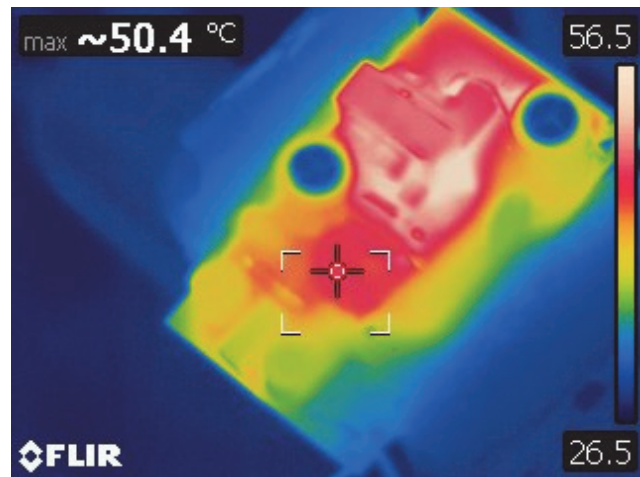

Figure 31 – 115 VAC 60 Hz, Full Load.
PFC Inductor: 50.4 °C.

13.1.3 Thermal Scan at 230 VAC Full Load



Figure 32 – 230 VAC 50 Hz, Full Load.
LYTSwitch-6 (U1): 71.2 °C.

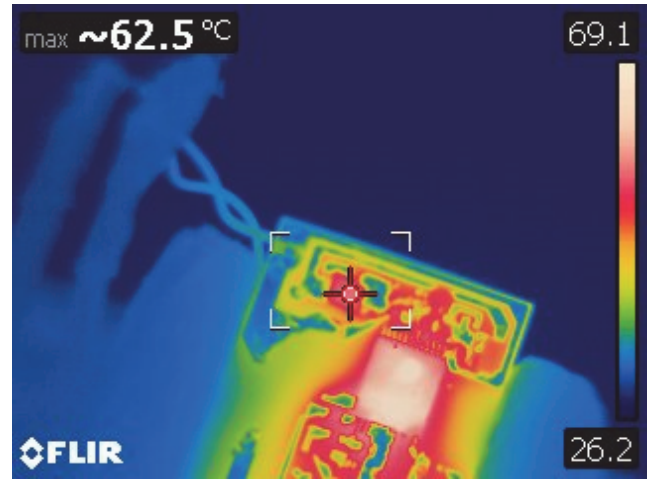

Figure 33 – 230 VAC 50 Hz, Full Load.
Output Diode (D6): 62.5 °C.

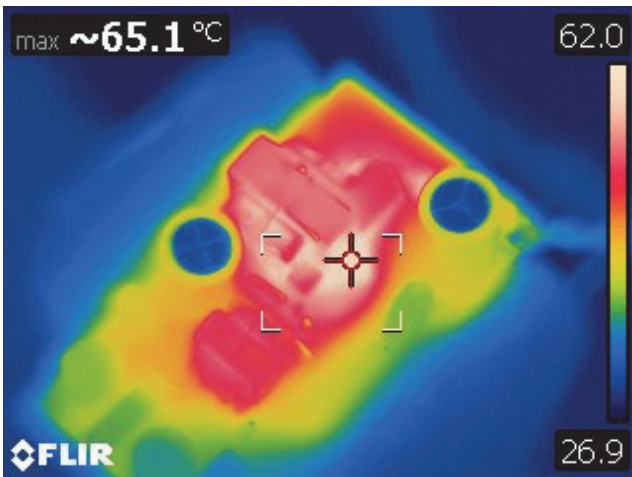

Figure 34 – 230 VAC 50 Hz, Full Load.
Power Transformer (T1): 65.1 °C.

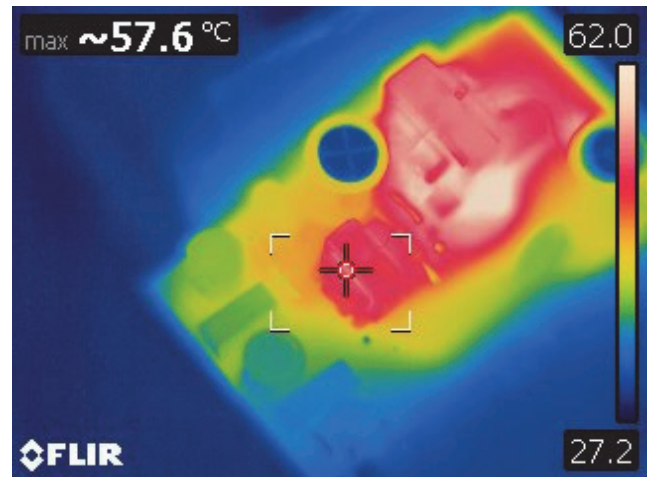

Figure 35 – 230 VAC 50 Hz, Full Load.
PFC Inductor: 57.6 °C.

13.1.4 Thermal Scan at 265 VAC Full Load

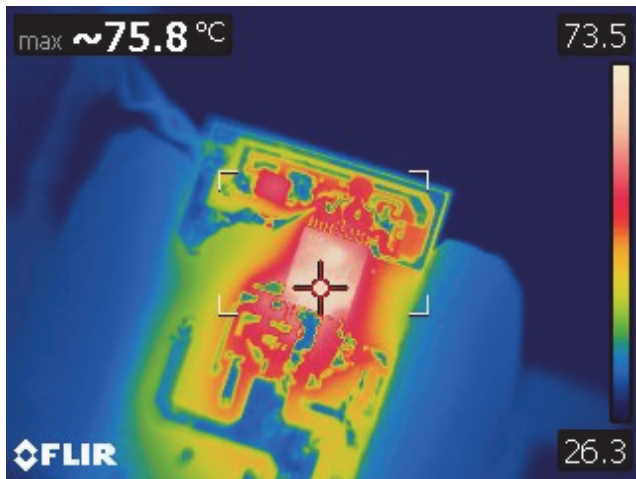

Figure 36 – 265 VAC 50 Hz, Full Load.
LYTSwitch-6 (U1): 75.8 °C.

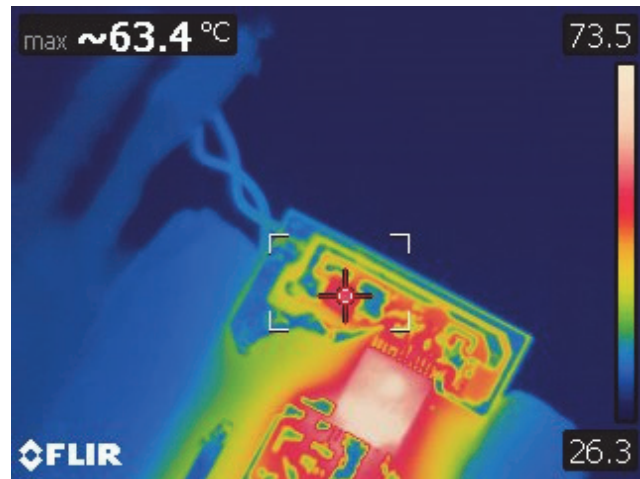

Figure 37 – 265 VAC 50 Hz, Full Load.
Output Diode (D6): 63.4 °C.

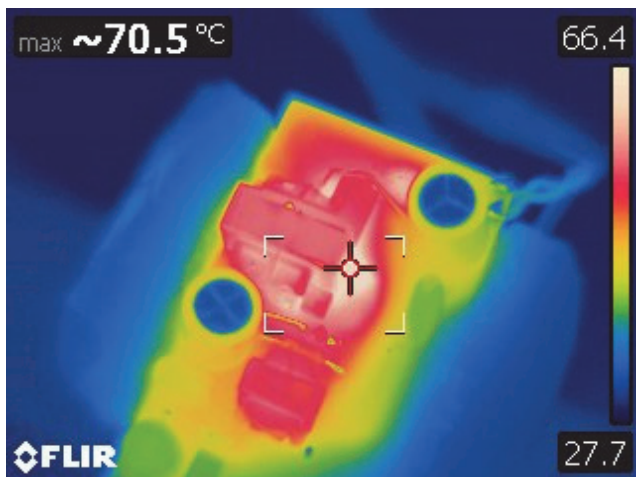

Figure 38 – 265 VAC 50 Hz, Full Load.
Power Transformer (T1): 70.5 °C.

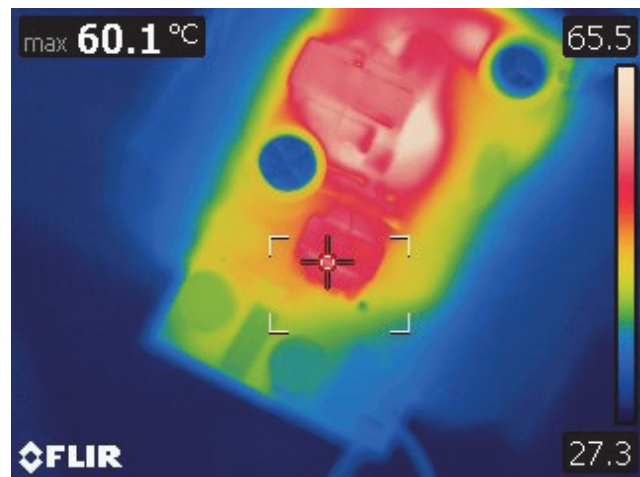

Figure 39 – 265 VAC 50 Hz, Full Load.
PFC Inductor: 60.1 °C.

13.2 Thermal Performance at 70 °C Ambient

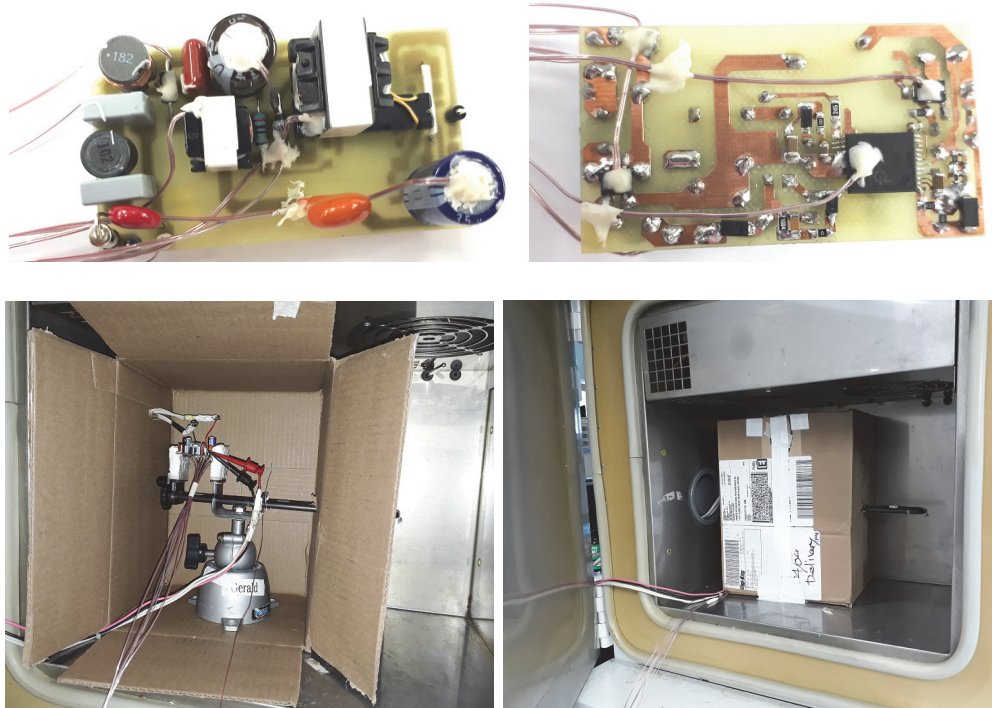

Figure 40 – Test Set-up Picture Thermal at 70 °C Ambient - Open Frame.

Open frame unit was placed inside the enclosure to prevent airflow that may affect the thermal measurements. Ambient temperature inside enclosure is 70 °C. Temperature was measured using Type T thermocouple. Soak time at full load is 1 hour and 30 minutes.

No.	Component	Thermal Data (°C)			
		90 V	115 V	230 V	265 V
1	Ambient Temperature	71.9	71.9	71.4	71.4
2	D1 – Blocking Diode	89.9	87.6	87	87.3
3	C4 – Bulk Capacitor	87.6	86.2	87.1	87.7
4	T1 – Power Transformer	97	96	97.6	104.2
5	BR1 – Bridge Diode	88.5	85.5	82.4	82.1
6	U1 – LYTSwitch-6	106	103	107	109.7
7	T2 – PFC Inductor	89.3	89	92.2	98
8	C10 – Output Capacitor	83.2	83	83.2	84.1
9	D6 – Output Diode	98.9	98.2	99.6	99.1



14 Waveforms

Waveforms were taken room temperature (25 °C).

14.1 Input Voltage and Input Current at Full Load

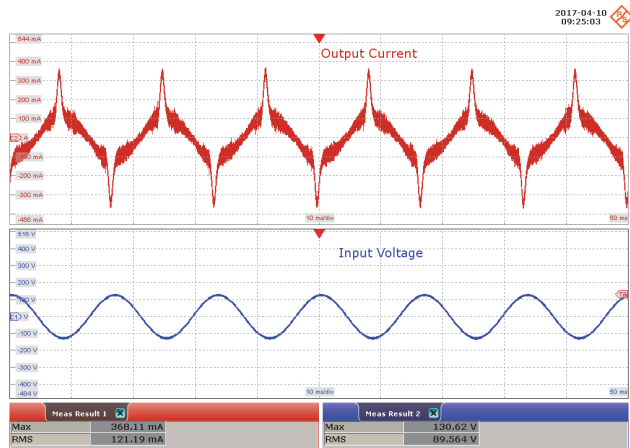

Figure 41 – 90 VAC 60 Hz, Full Load.
Upper: I_{IN} , 100 mA / div.
Lower: V_{IN} , 100 V / div., 10 ms / div.

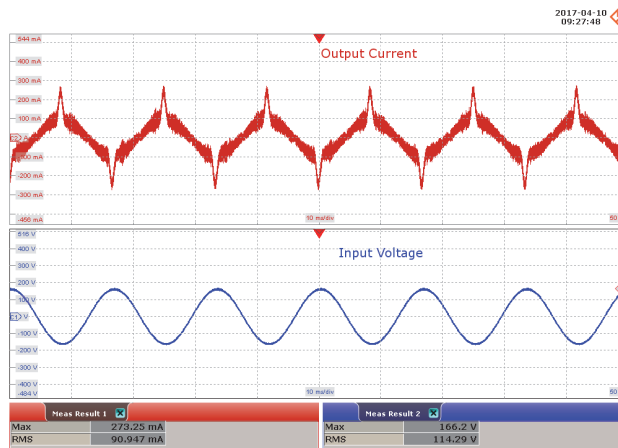

Figure 42 – 115 VAC 60 Hz, Full Load.
Upper: I_{IN} , 100 mA / div.
Lower: V_{IN} , 100 V / div., 10 ms / div.

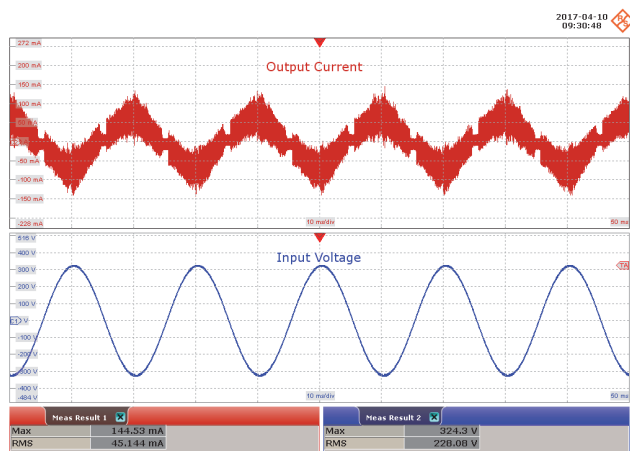

Figure 43 – 230 VAC 50 Hz, Full Load.
Upper: I_{IN} , 50 mA / div.
Lower: V_{IN} , 100 V / div., 10 ms / div.

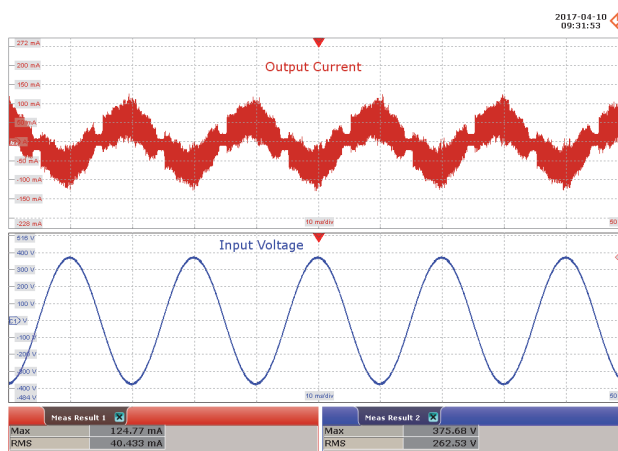

Figure 44 – 265 VAC 50 Hz, Full Load.
Upper: I_{IN} , 50 mA / div.
Lower: V_{IN} , 100 V / div., 10 ms / div.

14.2 Start-up Profile at Full Load

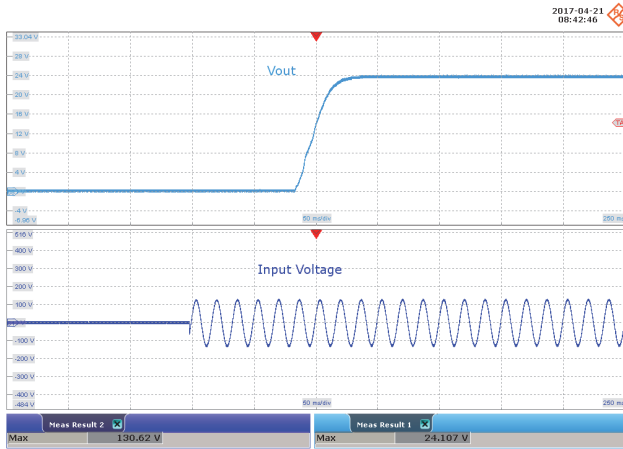

Figure 45 – 90 VAC 60 Hz, Full Load Start-up.
 Upper: V_{OUT} , 4 V / div.
 Lower: V_{IN} , 100 V / div., 50 ms / div.
 Turn-On Time: 120 ms.

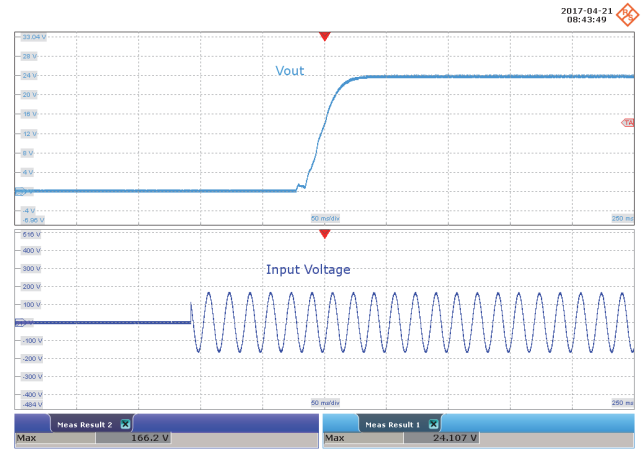

Figure 46 – 115 VAC 60 Hz, Full Load Start-up.
 Upper: V_{OUT} , 4 V / div.
 Lower: V_{IN} , 100 V / div., 50 ms / div.
 Turn-On Time: 125 ms.

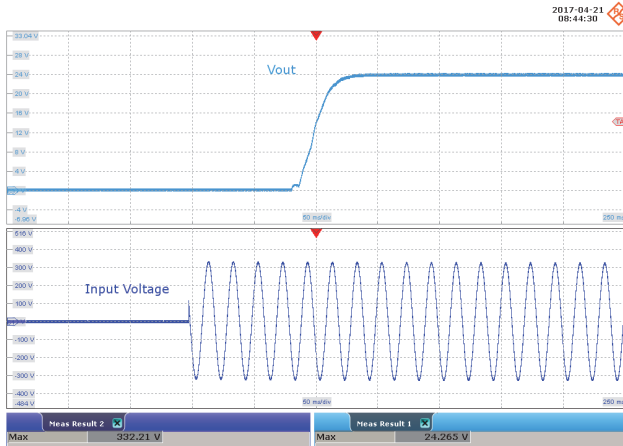

Figure 47 – 230 VAC 50 Hz, Full Load Start-up.
 Upper: V_{OUT} , 4 V / div.
 Lower: V_{IN} , 100 V / div., 50 ms / div.
 Turn-On Time: 120 ms.

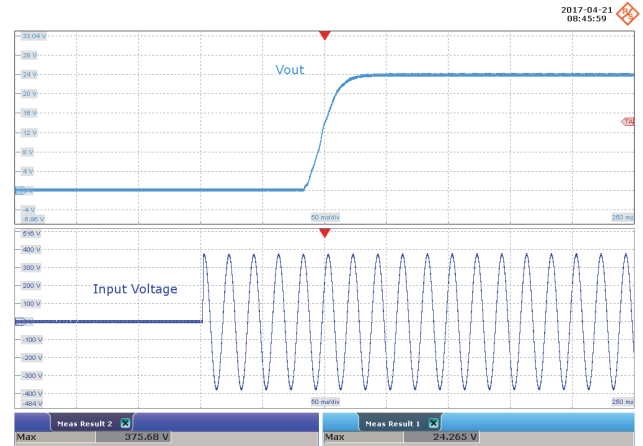

Figure 48 – 265 VAC 50 Hz, Full Load Start-up.
 Upper: V_{OUT} , 4 V / div.
 Lower: V_{IN} , 100 V / div., 50 ms / div.
 Turn-On Time: 116 ms.



14.3 Output Voltage Fall

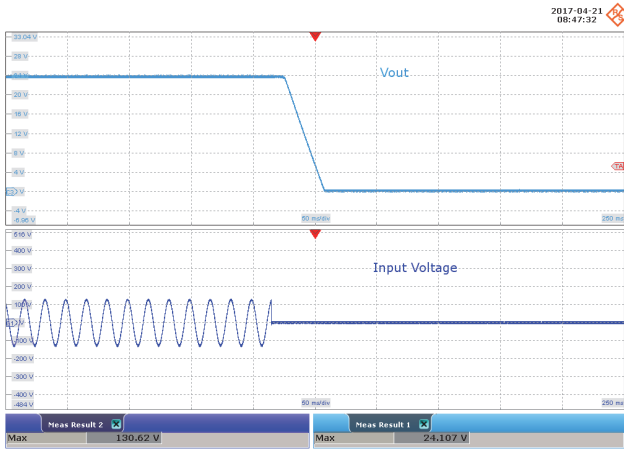

Figure 49 – 90 VAC 60 Hz, Full Load, Output Fall.
 Upper: V_{OUT} , 4 V / div.
 Lower: V_{IN} , 100 V / div., 50 ms / div.
 Hold-Up Time: 12.5 ms.

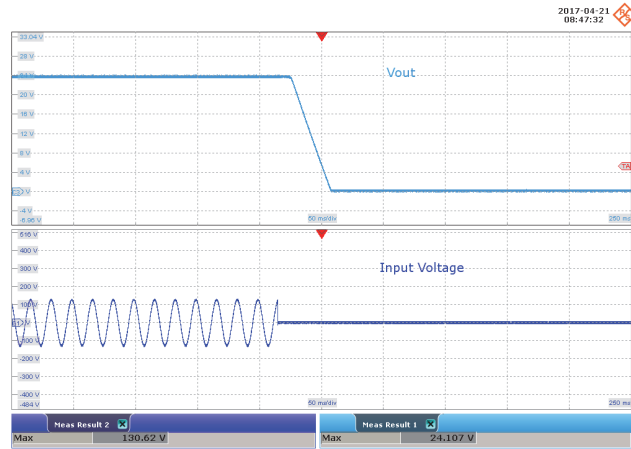

Figure 50 – 115 VAC 60 Hz, Full Load, Output Fall.
 Upper: V_{OUT} , 4 V / div.
 Lower: V_{IN} , 100 V / div., 50 ms / div.
 Hold-Up Time: 22 ms.

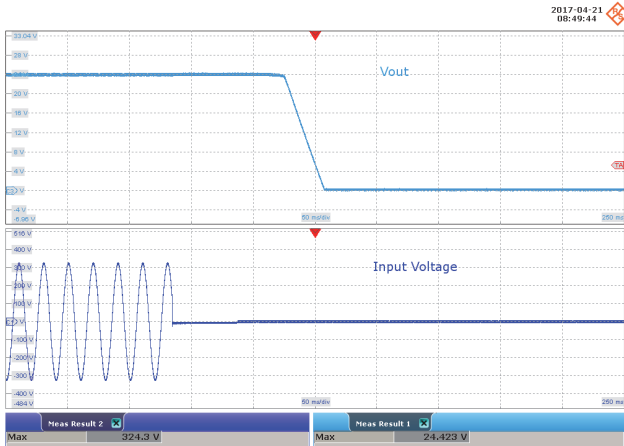

Figure 51 – 230 VAC 50 Hz, Full Load, Output Fall.
 Upper: V_{OUT} , 4 V / div.
 Lower: V_{IN} , 100 V / div., 50 ms / div.
 Hold-Up Time: 92 ms.

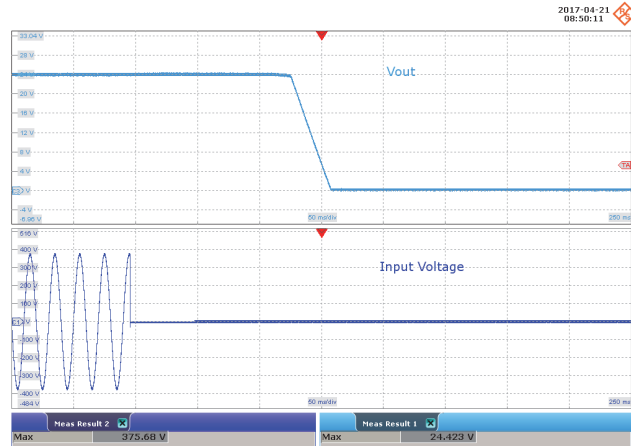

Figure 52 – 265 VAC 50 Hz, Full Load, Output Fall.
 Upper: V_{OUT} , 4 V / div.
 Lower: V_{IN} , 100 V / div., 50 ms / div.
 Hold-Up Time: 131 ms.

14.4 Power Cycling

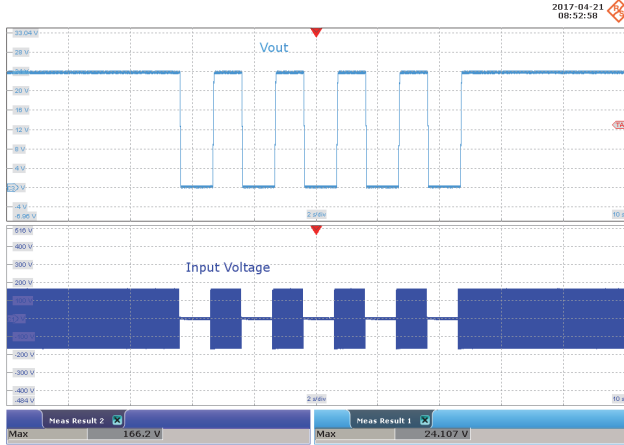

Figure 53 – 115 VAC 60 Hz, Full Load.
 1 s Off, 1 s On.
 Upper: V_{OUT} , 4 V / div.
 Lower: V_{IN} , 100 V / div., 2 s / div.

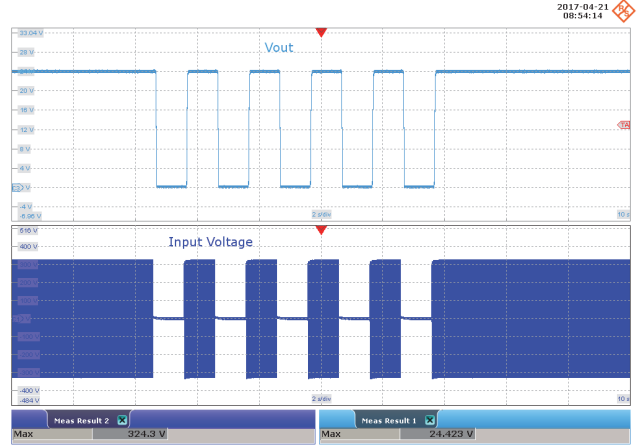

Figure 54 – 230 VAC 50 Hz, Full Load.
 1 s Off, 1 s On.
 Upper: V_{OUT} , 4 V / div.
 Lower: V_{IN} , 100 V / div., 2 s / div.

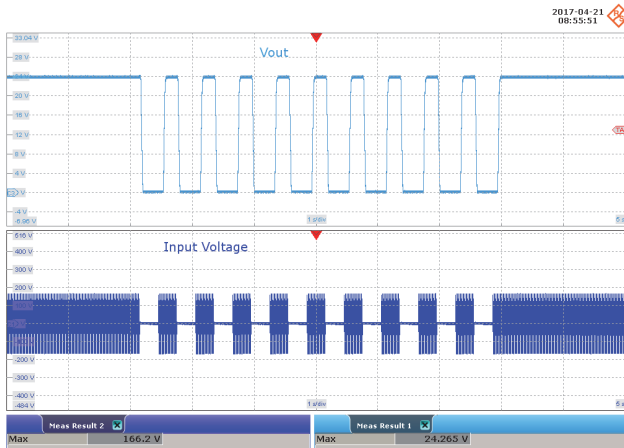

Figure 55 – 115 VAC 60 Hz, Full Load.
 0.3 s Off, 0.3 s On.
 Upper: V_{OUT} , 4 V / div.
 Lower: V_{IN} , 100 V / div., 1 s / div.

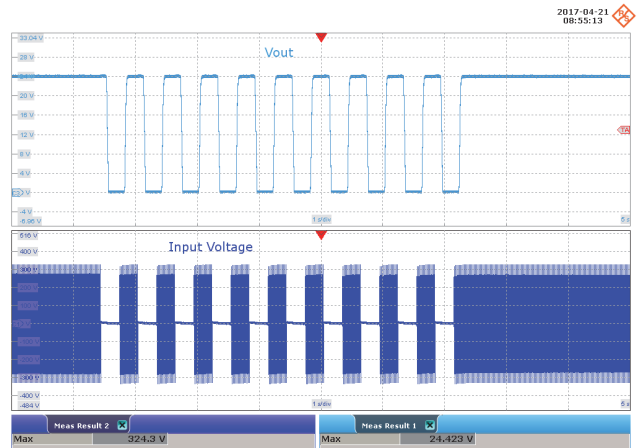

Figure 56 – 230 VAC 50 Hz, Full Load.
 0.3 s Off, 0.3 s On.
 Upper: V_{OUT} , 4 V / div.
 Lower: V_{IN} , 100 V / div., 1 s / div.



14.5 Load Transient Response 3 Hz

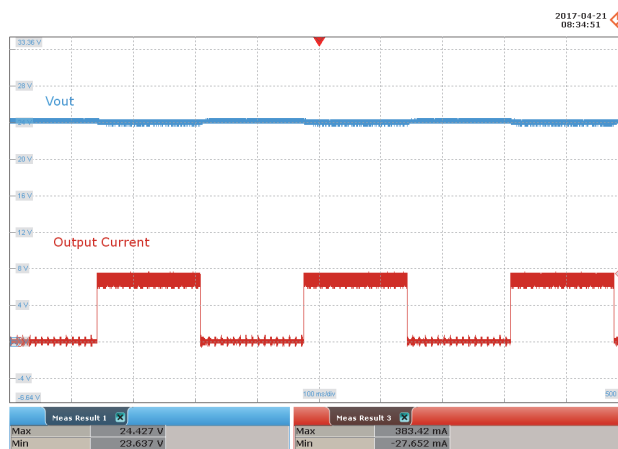
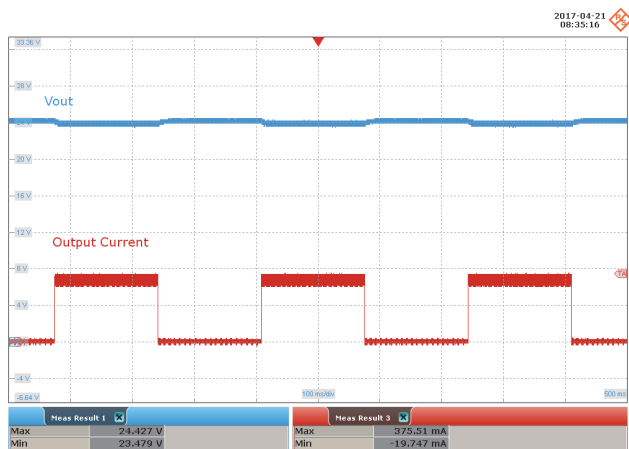

Figure 57 – 115 VAC 60 Hz.
 0% to 100% Load Change.
 3 Hz, 50% Duty Cycle.
 Slew Rate: 800 mA / μ s.
 Upper: V_{OUT} , 4 V / div., 100 ms / div.
 Lower: I_{OUT} , 200 mA / div.

Figure 58 – 230 VAC 50 Hz.
 0% to 100% Load Change.
 3 Hz, 50% Duty Cycle.
 Slew Rate: 800 mA / μ s.
 Upper: V_{OUT} , 4 V / div., 100 ms / div.
 Lower: I_{OUT} , 200 mA / div.

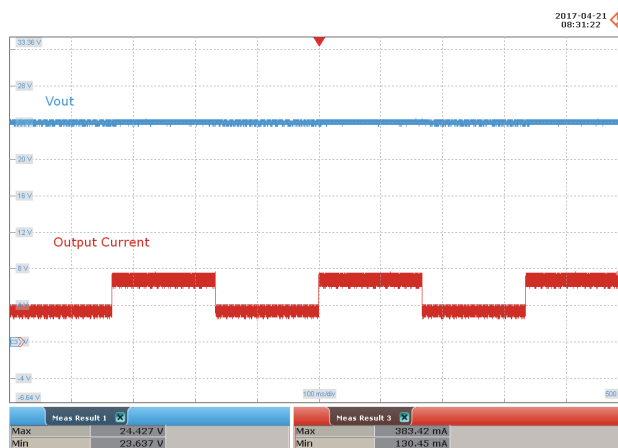
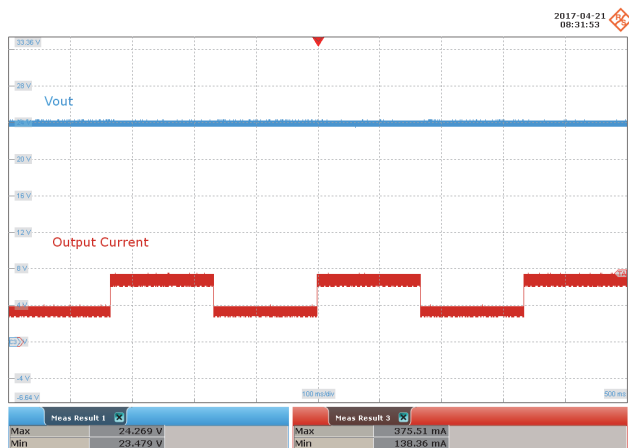

Figure 59 – 115 VAC 60 Hz.
 50% to 100% Load Change.
 3 Hz, 50% Duty Cycle.
 Slew Rate: 800 mA / μ s.
 Upper: V_{OUT} , 4 V / div., 100 ms / div.
 Lower: I_{OUT} , 200 mA / div.

Figure 60 – 230 VAC 50 Hz.
 50% to 100% Load Change.
 3 Hz, 50% Duty Cycle.
 Slew Rate: 800 mA / μ s.
 Upper: V_{OUT} , 4 V / div., 100 ms / div.
 Lower: I_{OUT} , 200 mA / div.

14.6 Load Transient Response 100 Hz

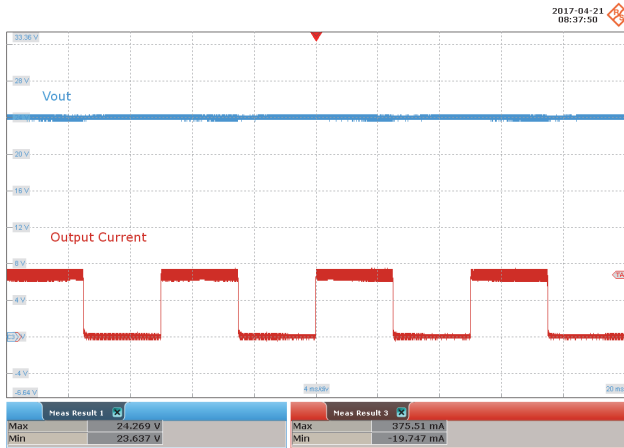

Figure 61 – 115 VAC 60 Hz.
 0% to 100% Load Change.
 100 Hz, 50% Duty Cycle.
 Slew Rate: 800 mA / μ s.
 Upper: V_{OUT} , 4 V / div., 4 ms / div.
 Lower: I_{OUT} , 200 mA / div.

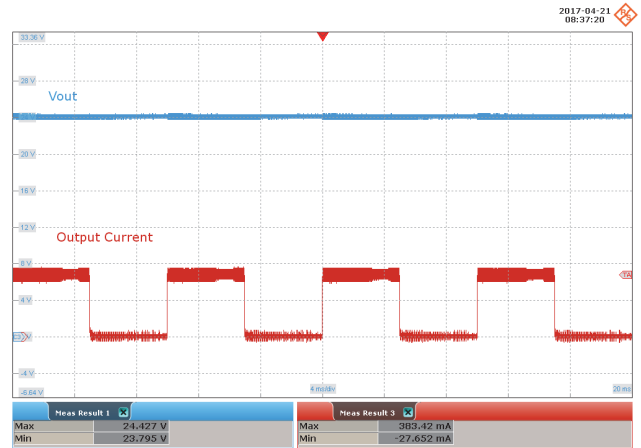

Figure 62 – 230 VAC 50 Hz.
 0% to 100% Load Change.
 3 Hz, 50% Duty Cycle.
 Slew Rate: 800 mA / μ s.
 Upper: V_{OUT} , 4 V / div., 4 ms / div.
 Lower: I_{OUT} , 200 mA / div.

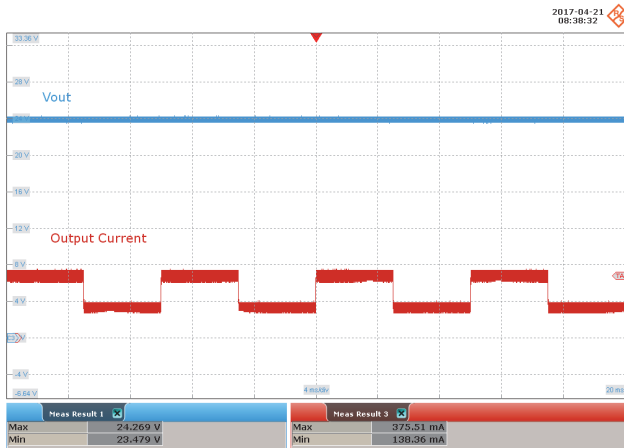

Figure 63 – 115 VAC 60 Hz.
 50% to 100% Load Change.
 100 Hz, 50% Duty Cycle.
 Slew Rate: 800 mA / μ s.
 Upper: V_{OUT} , 4 V / div., 4 ms / div.
 Lower: I_{OUT} , 200 mA / div.

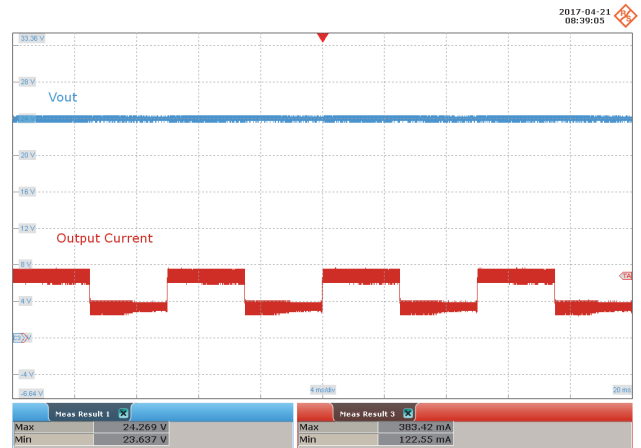

Figure 64 – 230 VAC 50 Hz, Full Load.
 50% to 100% Load Change.
 100 Hz, 50% Duty Cycle.
 Slew Rate: 800 mA / μ s.
 Upper: V_{OUT} , 4 V / div., 4 ms / div.
 Lower: I_{OUT} , 200 mA / div.



14.7 LYTSwitch-6 Drain Voltage and Current Waveforms

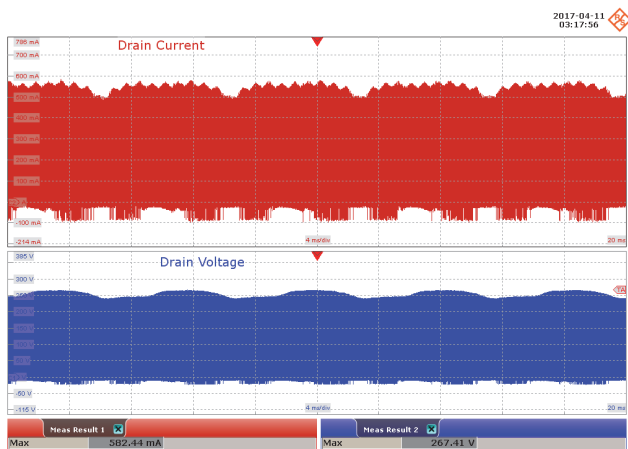

Figure 65 – 90 VAC 60 Hz, Full Load Normal.
 Upper: I_{DRAIN} , 100 mA / div.
 Lower: V_{DRAIN} , 50 V / div., 4 ms / div.



Figure 66 – 90 VAC 60 Hz, Full Load Normal.
 Upper: I_{DRAIN} , 100 mA / div.
 Lower: V_{DRAIN} , 50 V / div., 10 μ s / div.

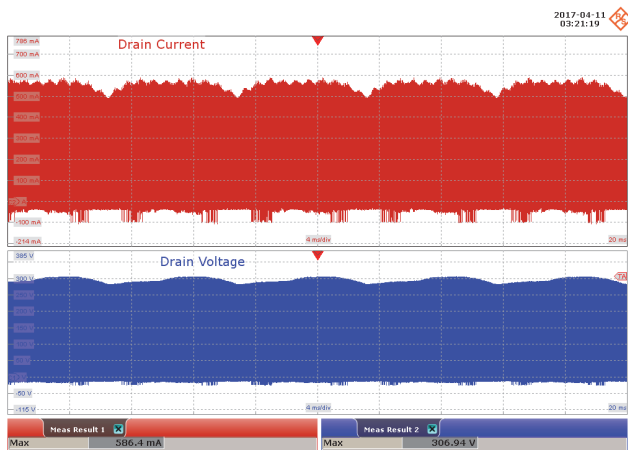

Figure 67 – 115 VAC 60 Hz, Full Load Normal.
 Upper: I_{DRAIN} , 100 mA / div.
 Lower: V_{DRAIN} , 50 V / div., 4 ms / div.



Figure 68 – 115 VAC 60 Hz, Full Load Normal.
 Upper: I_{DRAIN} , 100 mA / div.
 Lower: V_{DRAIN} , 50 V / div., 10 μ s / div.

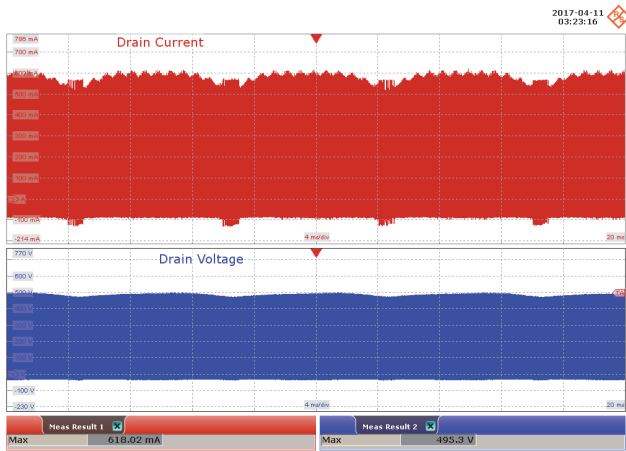

Figure 69 – 230 VAC 50 Hz, Full Load Normal.
 Upper: I_{DRAIN} , 100 mA / div.
 Lower: V_{DRAIN} , 100 V / div., 4 ms / div.

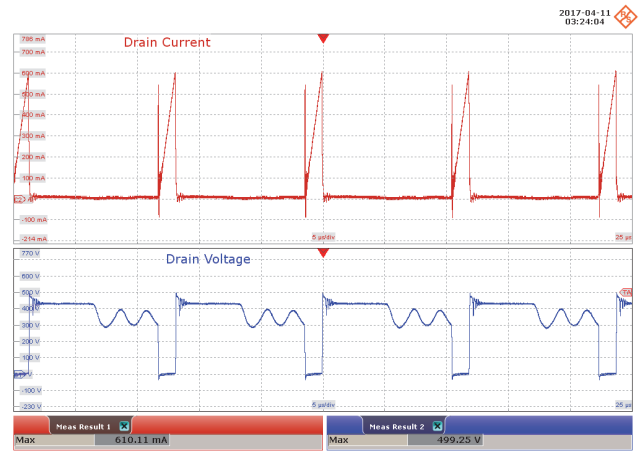

Figure 70 – 230 VAC 50 Hz, Full Load Normal.
 Upper: I_{DRAIN} , 100 mA / div.
 Lower: V_{DRAIN} , 100 V / div., 5 μ s / div.

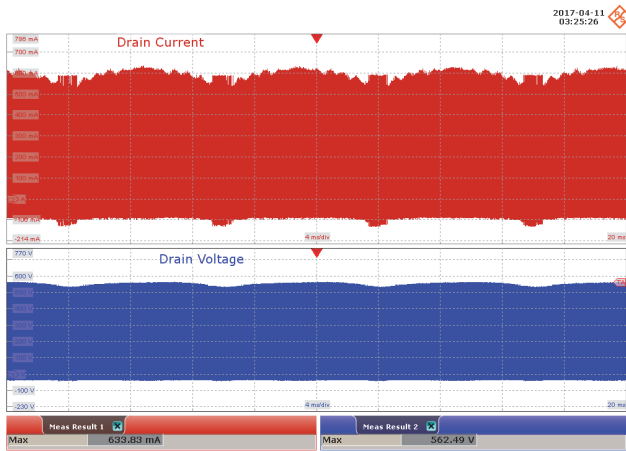

Figure 71 – 265 VAC 50 Hz, Full Load Normal.
 Upper: I_{DRAIN} , 100 mA / div.
 Lower: V_{DRAIN} , 100 V / div., 4 ms / div.

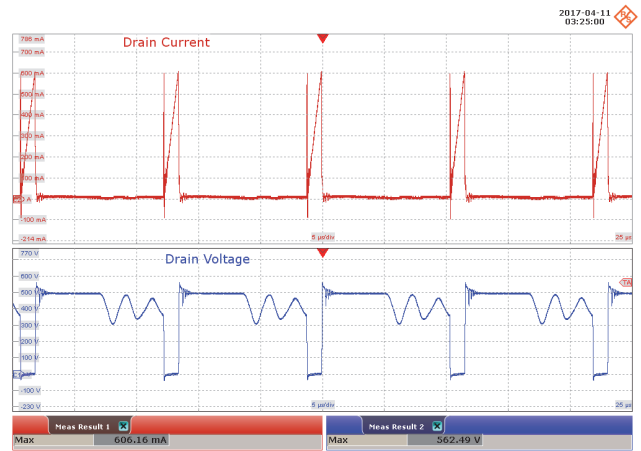

Figure 72 – 265 VAC, Full Load Normal.
 Upper: I_{DRAIN} , 100 mA / div.
 Lower: V_{DRAIN} , 100 V / div., 5 μ s / div.



14.8 LYTSwitch-6 Drain Voltage and Current at Full Load Start-up

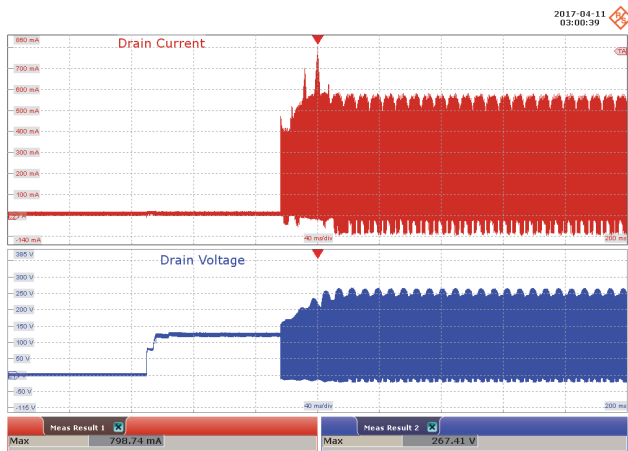

Figure 73 – 90 VAC 60 Hz, Full Load Start-up.
Upper: I_{DRAIN} , 100 mA / div.
Lower: V_{DRAIN} , 50 V / div., 4 ms / div.



Figure 74 – 90 VAC 60 Hz, Full Load Start-up.
Upper: I_{DRAIN} , 100 mA / div.
Lower: V_{DRAIN} , 50 V / div., 5 μ s / div.

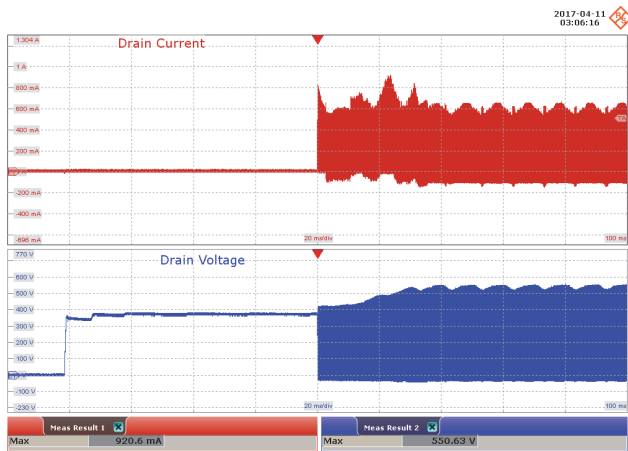

Figure 75 – 265 VAC, Full Load Start-up.
Upper: I_{DRAIN} , 200 mA / div.
Lower: V_{DRAIN} , 100 V / div., 40 ms / div.

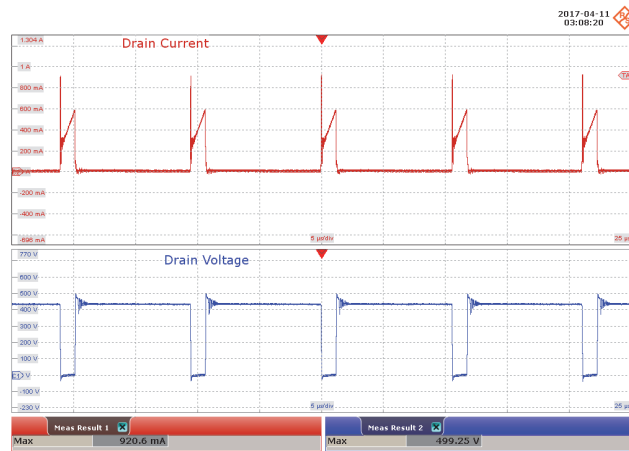

Figure 76 – 265 VAC, Full Load Start-up.
Upper: I_{DRAIN} , 200 mA / div.
Lower: V_{DRAIN} , 100 V / div., 5 μ s / div.

14.9 LYTSwitch-6 Drain Voltage and Current During Output Short-Circuit



Figure 77 – 90 VAC 60 Hz, Output Shorted.
Upper: I_{DRAIN} , 100 mA / div.
Lower: V_{DRAIN} , 40 V / div., 1 s / div.

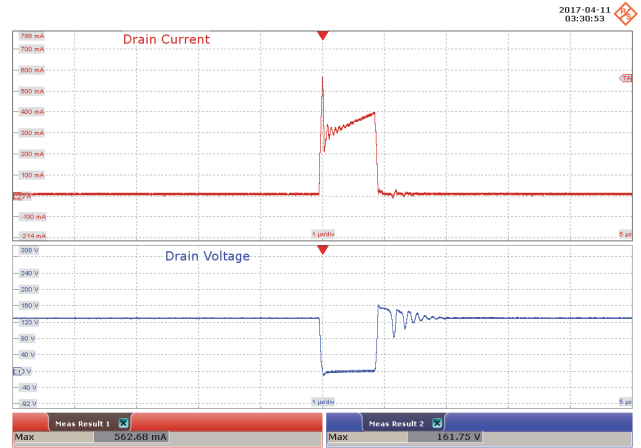

Figure 78 – 90 VAC 60 Hz, Output Shorted.
Upper: I_{DRAIN} , 100 mA / div.
Lower: V_{DRAIN} , 40 V / div., 1 μ s / div.



Figure 79 – 265 VAC, Output Shorted.
Upper: I_{DRAIN} , 200 mA / div.
Lower: V_{DRAIN} , 100 V / div., 1 s / div.

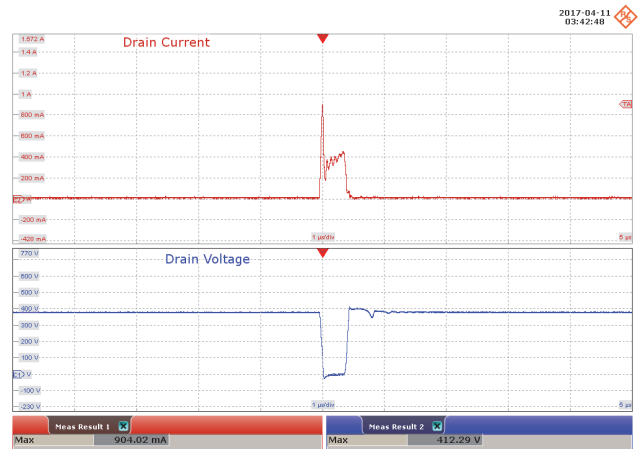

Figure 80 – 265 VAC, Output Shorted.
Upper: I_{DRAIN} , 200 mA / div.
Lower: V_{DRAIN} , 100 V / div., 1 μ s / div.

14.10 Input Power During Output Short-Circuit

Input		Input Measurement		
VAC (V_{RMS})	Freq (Hz)	V_{IN} (V_{RMS})	I_{IN} (mA_{RMS})	P_{IN} (mW)
90	60	90.00	4.66	14.310
115	60	114.97	4.71	17.772
132	60	131.95	4.94	19.998
185	50	184.93	5.16	28.710
230	50	229.95	5.60	51.798
265	50	264.96	6.58	73.752



14.11 Output Ripple Voltage

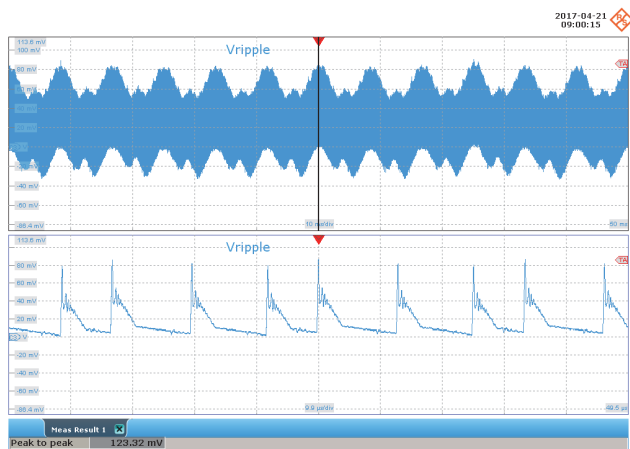

Figure 81 – 90 VAC 60 Hz, Full Load.
 AC Coupling, 20 MHz Bandwidth.
 V_{OUT} , 20 mV / div., 10 ms / div.
 Ripple Voltage: 123.3 mV_{PK-PK}.

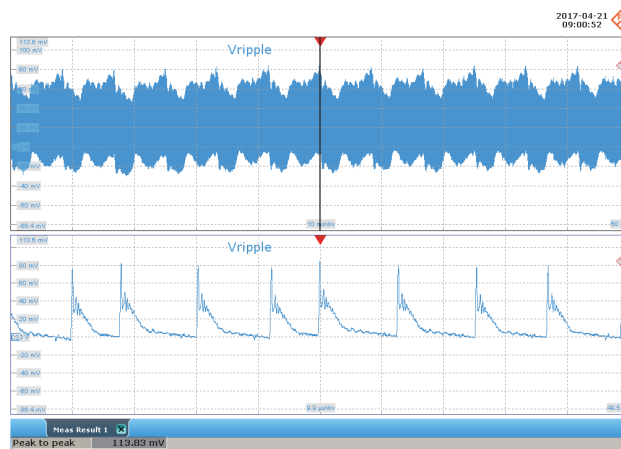

Figure 82 – 115 VAC 60 Hz, Full Load.
 AC Coupling, 20 MHz Bandwidth.
 V_{OUT} , 20 mV / div., 10 ms / div.
 Ripple Voltage: 113.8 mV_{PK-PK}.

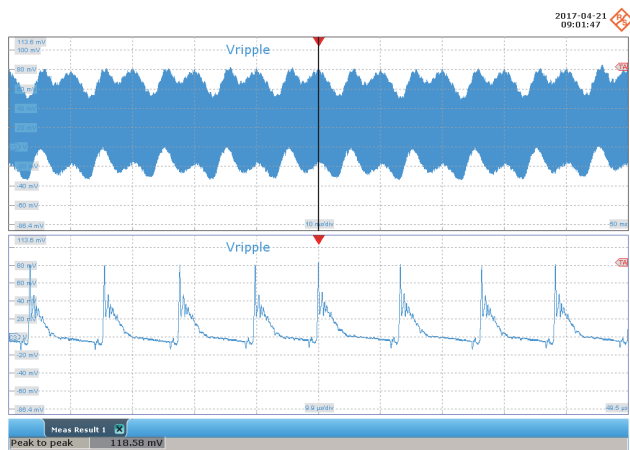

Figure 83 – 230 VAC 50 Hz, Full Load.
 AC Coupling, 20 MHz Bandwidth.
 V_{OUT} , 20 mV / div., 10 ms / div.
 Ripple Voltage: 118.6 mV_{PK-PK}.

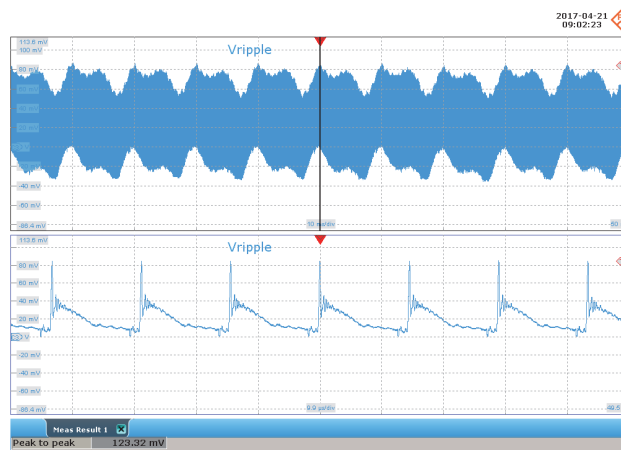

Figure 84 – 265 VAC 50 Hz, Full Load.
 AC Coupling, 20 MHz Bandwidth.
 V_{OUT} , 20 mV / div., 10 ms / div.
 Ripple Voltage: 114.6 mV_{PK-PK}.

15 Conducted EMI

15.1 Test Set-up

LED metal heatsink is connected to ground. Unit with input ground wire connection is placed on top of LED metal heat sink. See set-up picture below.

15.2 Equipment and Load Used

1. Rohde and Schwarz ENV216 two line V-network.
2. Rohde and Schwarz ESRP EMI test receiver.
3. Hioki 3322 power hitester.
4. Chroma measurement test fixture.
5. Full Load with input voltage set at 230 VAC 50 Hz and 115 VAC.

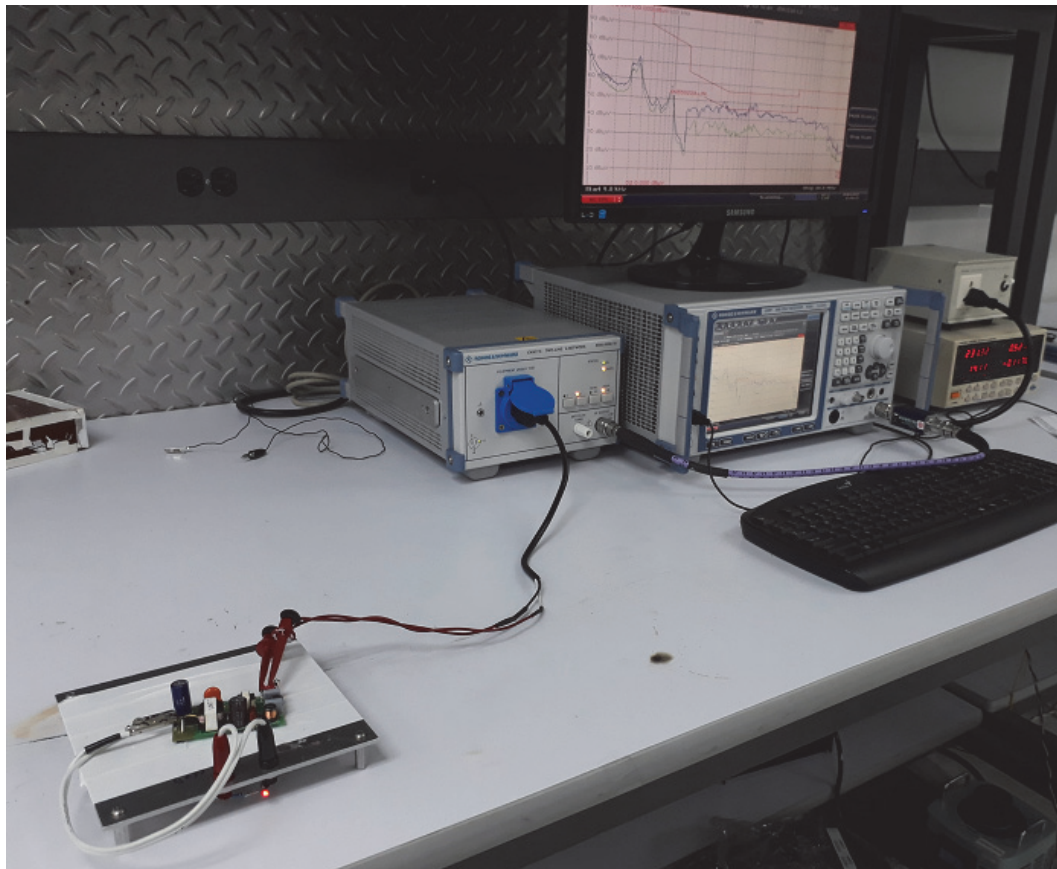
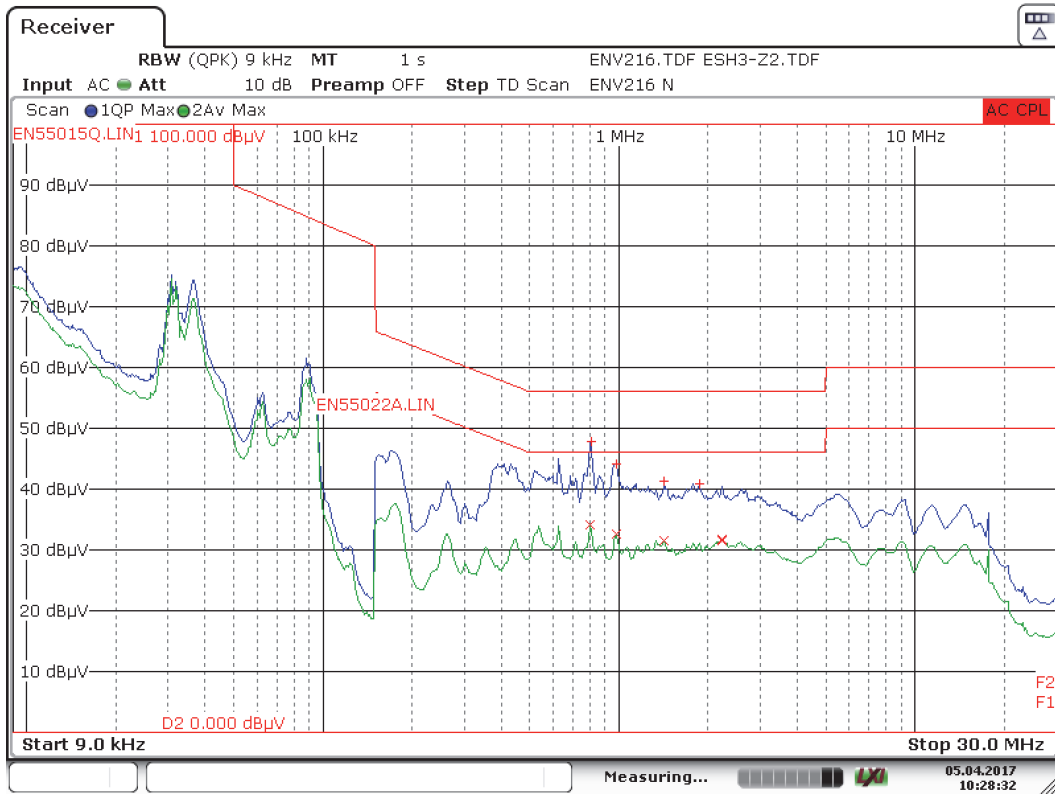

Figure 85 — Conducted EMI Test Set-up.

15.3 EMI Test Result



Date: 5.APR.2017 10:28:32

Figure 86 – Conducted EMI QP Scan at Full Load, 115 VAC 60 Hz and EN55015 B Limits.

Trace/Detector	Frequency	Level dBµV	DeltaLimit
2 Average	802.5000 kHz	34.14 N	-11.86 dB
1 Quasi Peak	804.7500 kHz	47.89 N	-8.11 dB
2 Average	980.2500 kHz	32.61 N	-13.39 dB
1 Quasi Peak	982.5000 kHz	44.13 N	-11.87 dB
2 Average	1.4258 MHz	31.51 N	-14.49 dB
1 Quasi Peak	1.4280 MHz	41.39 N	-14.61 dB
1 Quasi Peak	1.8803 MHz	40.86 L1	-15.14 dB
2 Average	2.2335 MHz	31.67 N	-14.33 dB
2 Average	2.2380 MHz	31.60 N	-14.40 dB

Figure 87 – Conducted EMI Data at 115 VAC 60 Hz, Full Load.

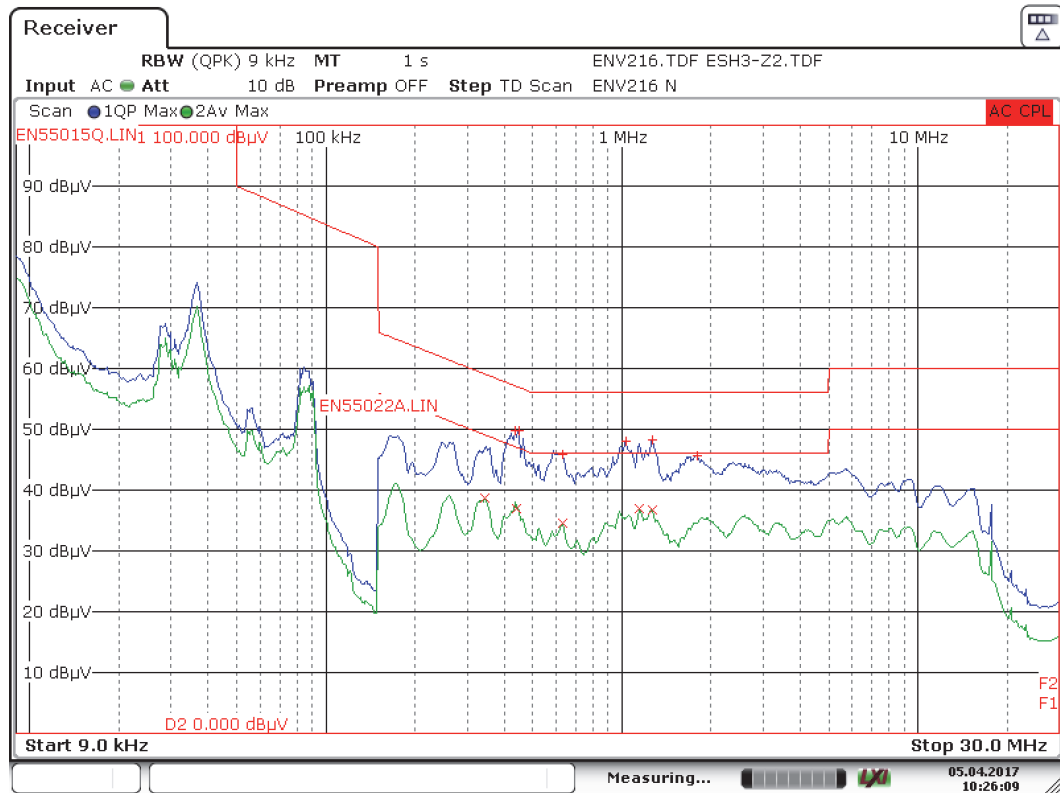

Date: 5.APR.2017 10:26:08

Figure 88 – Conducted EMI QP Scan at Full Load, 230 VAC 60 Hz and EN55015 B Limits.

Trace/Detector	Frequency	Level dBµV	DeltaLimit
2 Average	345.7500 kHz	38.61 N	-10.45 dB
1 Quasi Peak	435.7500 kHz	49.73 N	-7.41 dB
2 Average	442.5000 kHz	36.99 N	-10.02 dB
1 Quasi Peak	449.2500 kHz	49.86 N	-7.03 dB
1 Quasi Peak	631.5000 kHz	45.84 N	-10.16 dB
2 Average	631.5000 kHz	34.54 N	-11.46 dB
1 Quasi Peak	1.0320 MHz	48.01 L1	-7.99 dB
2 Average	1.1490 MHz	36.85 N	-9.15 dB
1 Quasi Peak	1.2638 MHz	48.35 N	-7.65 dB
2 Average	1.2638 MHz	36.72 N	-9.28 dB
1 Quasi Peak	1.7993 MHz	45.67 N	-10.33 dB

Figure 89 – Conducted EMI Data at 230 VAC 60 Hz, Full Load.



16 Line Surge

The unit was subjected to ± 2500 V, 100 kHz ring wave and ± 2000 V differential surge using 10 strikes at each condition. A test failure was defined as a non-recoverable interruption of output requiring repair or recycling of input voltage.

16.1 Differential Surge Test Results

Surge Level (V)	Input Voltage (VAC)	Injection Location	Injection Phase (°)	Test Result (Pass/Fail)
+2000	230	L to N	0	Pass
-2000	230	L to N	0	Pass
+2000	230	L to N	90	Pass
-2000	230	L to N	90	Pass

16.2 Ring Wave Surge Test Results

Surge Level (V)	Input Voltage (VAC)	Injection Location	Injection Phase (°)	Test Result (Pass/Fail)
+2500	230	L to N	0	Pass
-2500	230	L to N	0	Pass
+2500	230	L to N	90	Pass
-2500	230	L to N	90	Pass

16.3 2 kV Differential Surge Test

The Drain voltage of U1-LYTSwitch-6 was measured during 2 kV differential surge test.

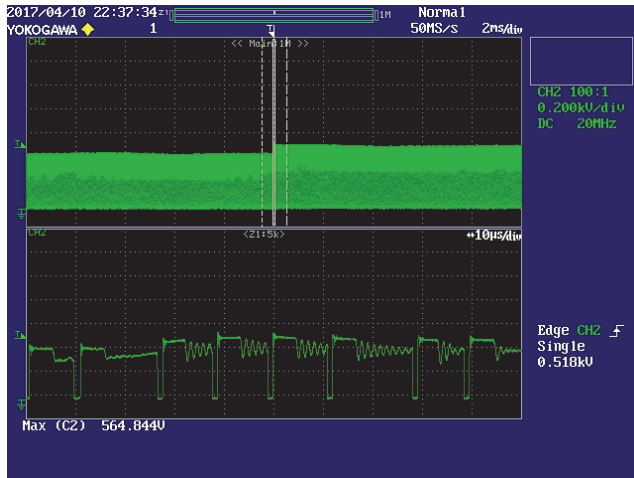

Figure 90 – (+)2 kV Differential Surge.
 90° Phase Angle.
 Lower: V_{DRAIN} , 200 V / div., 2 ms / div.
 Peak V_{DRAIN} : 564.84 V.

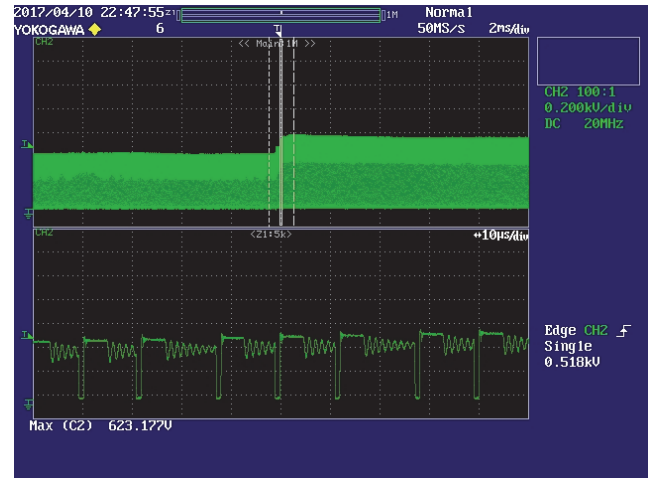

Figure 91 – (-)2 kV Differential Surge.
 90° Phase Angle.
 Lower: V_{DRAIN} , 200 V / div., 2 ms / div.
 Peak V_{DRAIN} : 623.18 V.

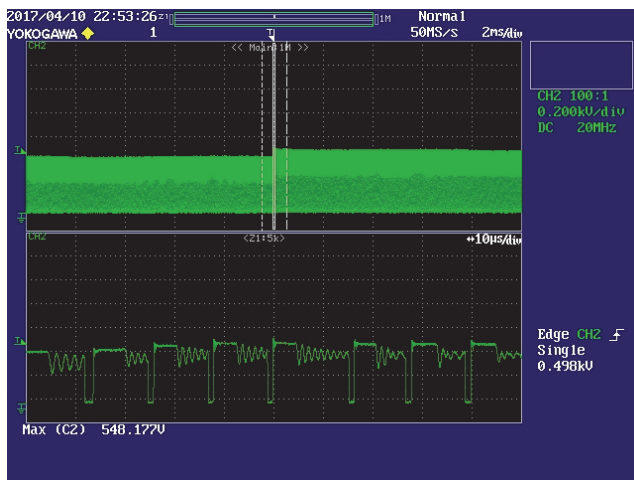

Figure 92 – (+)2 kV Differential Surge.
 90° Phase Angle.
 Lower: V_{DRAIN} , 200 V / div., 2 ms / div.
 Peak V_{DRAIN} : 548.18 V.

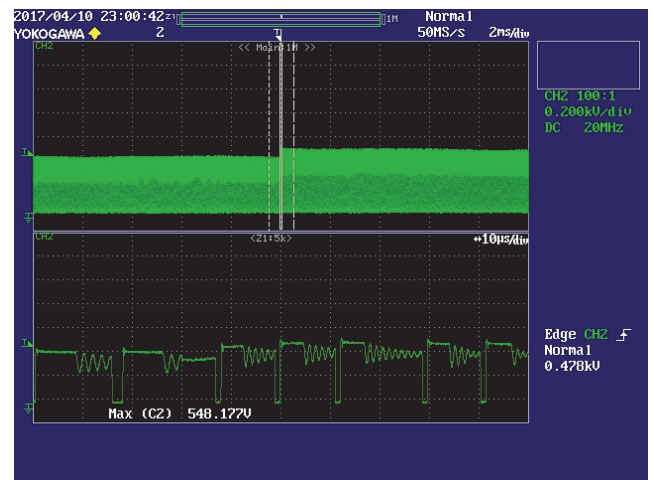

Figure 93 – (-)2 kV Differential Surge.
 90° Phase Angle.
 Lower: V_{DRAIN} , 200 V / div., 2 ms / div.
 Peak V_{DRAIN} : 548.18 V.



16.4 2.5 kV Ring Wave Surge Test

The Drain voltage of U1-LYTSwitch-6 was measured during 2 kV ring wave surge test.

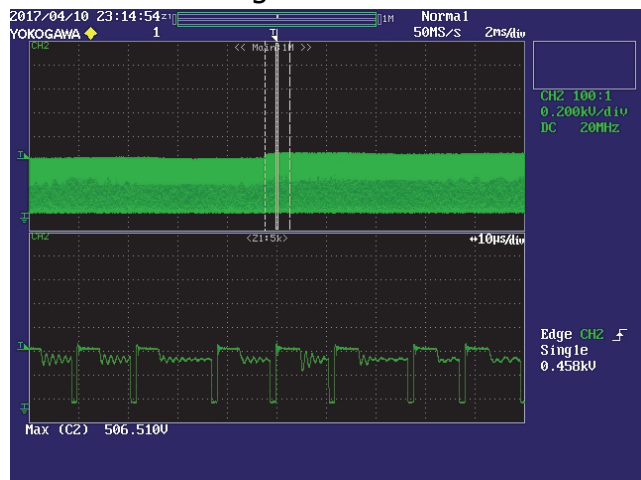

Figure 94 – (+) 2.5 kV Ring Wave Surge.
90° Phase Angle.
Lower: V_{DRAIN} , 200 V / div., 2 ms / div.
Peak V_{DRAIN} : 506.51 V.

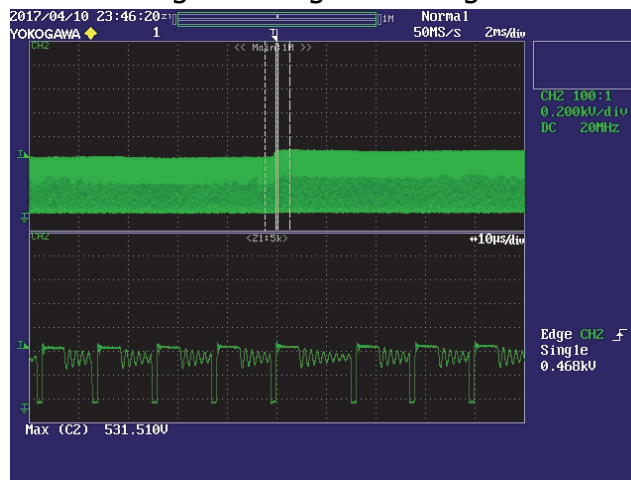

Figure 95 – (-) 2.5 kV Ringwave Surge.
90 ° Phase Angle.
Lower: V_{DRAIN} , 200 V / div., 2 ms / div.
Peak V_{DRAIN} : 531.51 V.

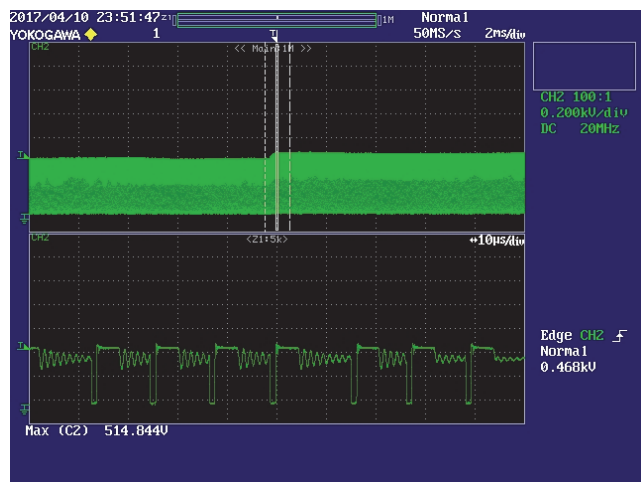

Figure 96 – (+) 2.5 kV Ring Wave Surge.
0° Phase Angle.
Lower: V_{DRAIN} , 200 V / div., 2 ms / div.
Peak V_{DRAIN} : 514.84 V.

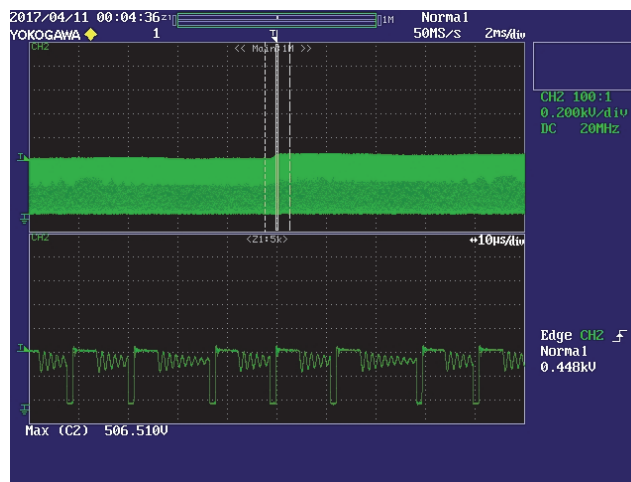

Figure 97 – (-) 2.5 kV Ringwave Surge.
0° Phase Angle.
Lower: V_{DRAIN} , 200 V / div., 2 ms / div.
Peak V_{DRAIN} : 506.51 V.

17 Brown-in / Brown-out Test

No abnormal overheating nor voltage overshoot / undershoot was observed during and after 0.5 V / s and 1 V / s brown-in and brown-out test.

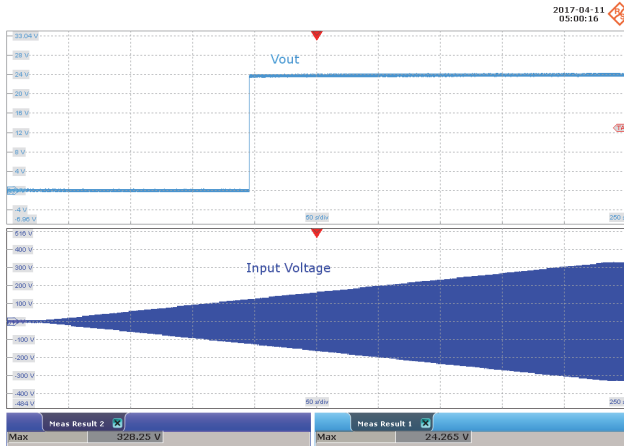

Figure 98 – Brown-in Test at 0.5 V / s.
 Ch1: V_{OUT} , 4 V / div.
 Ch2: V_{IN} , 100 V / div.
 Time Scale: 50 s / div.

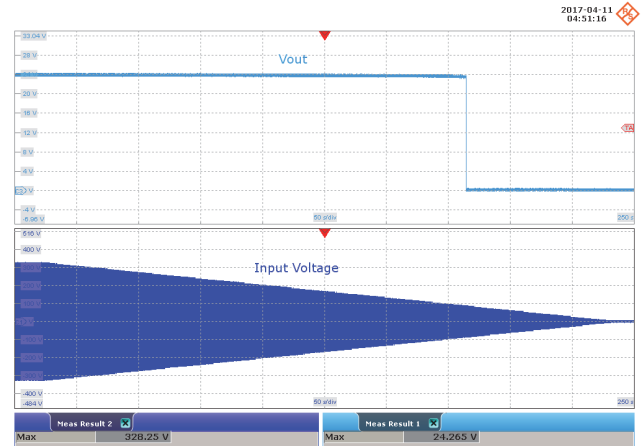

Figure 99 – Brown-out Test at 0.5 V / s.
 Ch1: V_{OUT} , 4 V / div.
 Ch2: V_{IN} , 100 V / div.
 Time Scale: 50 s / div.

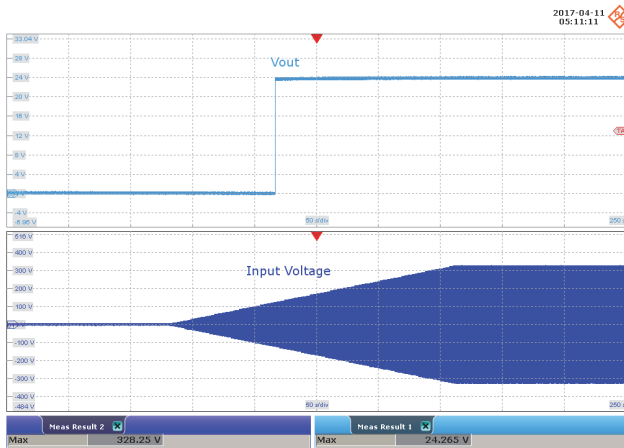

Figure 100 – Brown-in Test at 1 V / s.
 Ch1: V_{OUT} , 4 V / div.
 Ch2: V_{IN} , 100 V / div.
 Time Scale: 50 s / div.

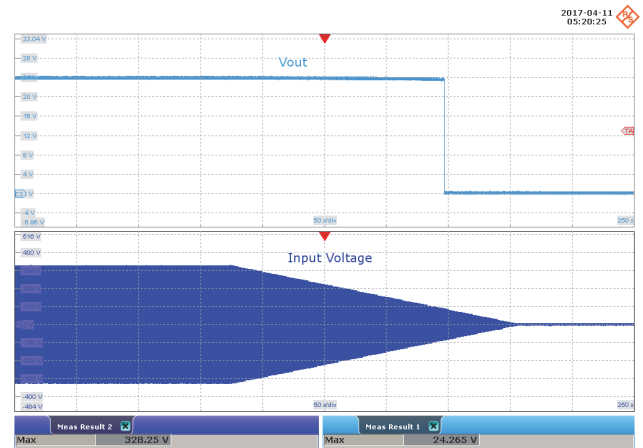

Figure 101 – Brown-out Test at 1 V / s.
 Ch1: V_{OUT} , 4 V / div.
 Ch2: V_{IN} , 100 V / div.
 Time Scale: 50 s / div.

18 Revision History

Date	Author	Revision	Description and Changes	Reviewed
05-Feb-18	MGM	1.0	Initial Release.	Apps & Mktg
16-Feb-18	MGM	1.1	Minor edits. PCB Images Updated.	
21-Feb-18	MGM	1.2	Added PIXIs Spreadsheet.	



For the latest updates, visit our website: www.power.com

Reference Designs are technical proposals concerning how to use Power Integrations' gate drivers in particular applications and/or with certain power modules. These proposals are "as is" and are not subject to any qualification process. The suitability, implementation and qualification are the sole responsibility of the end user. The statements, technical information and recommendations contained herein are believed to be accurate as of the date hereof. All parameters, numbers, values and other technical data included in the technical information were calculated and determined to our best knowledge in accordance with the relevant technical norms (if any). They may base on assumptions or operational conditions that do not necessarily apply in general. We exclude any representation or warranty, express or implied, in relation to the accuracy or completeness of the statements, technical information and recommendations contained herein. No responsibility is accepted for the accuracy or sufficiency of any of the statements, technical information, recommendations or opinions communicated and any liability for any direct, indirect or consequential loss or damage suffered by any person arising therefrom is expressly disclaimed.

Power Integrations reserves the right to make changes to its products at any time to improve reliability or manufacturability. Power Integrations does not assume any liability arising from the use of any device or circuit described herein. POWER INTEGRATIONS MAKES NO WARRANTY HEREIN AND SPECIFICALLY DISCLAIMS ALL WARRANTIES INCLUDING, WITHOUT LIMITATION, THE IMPLIED WARRANTIES OF MERCHANTABILITY, FITNESS FOR A PARTICULAR PURPOSE, AND NON-INFRINGEMENT OF THIRD PARTY RIGHTS.

Patent Information

The products and applications illustrated herein (including transformer construction and circuits' external to the products) may be covered by one or more U.S. and foreign patents, or potentially by pending U.S. and foreign patent applications assigned to Power Integrations. A complete list of Power Integrations' patents may be found at www.power.com. Power Integrations grants its customers a license under certain patent rights as set forth at <http://www.power.com/ip.htm>.

The PI Logo, TOPSwitch, TinySwitch, LinkSwitch, LYTSwitch, InnoSwitch, DPA-Switch, PeakSwitch, CAPZero, SENZero, LinkZero, HiperPFS, HiperTFS, HiperLCS, Qspeed, EcoSmart, Clampless, E-Shield, Filterfuse, FluxLink, StackFET, PI Expert and PI FACTS are trademarks of Power Integrations, Inc. Other trademarks are property of their respective companies. ©Copyright 2015 Power Integrations, Inc.

Power Integrations Worldwide Sales Support Locations

WORLD HEADQUARTERS

5245 Hellyer Avenue
San Jose, CA 95138, USA.
Main: +1-408-414-9200
Customer Service:
Phone: +1-408-414-9665
Fax: +1-408-414-9765
e-mail: usasales@power.com

GERMANY

(IGBT Driver Sales)
HellwegForum 1
59469 Ense, Germany
Tel: +49-2938-64-39990
Email: igbt-driver.sales@power.com

KOREA

RM 602, 6FL
Korea City Air Terminal B/D,
159-6
Samsung-Dong, Kangnam-Gu,
Seoul, 135-728 Korea
Phone: +82-2-2016-6610
Fax: +82-2-2016-6630
e-mail: koreasales@power.com

CHINA (SHANGHAI)

Rm 2410, Charity Plaza, No.
88,
North Caoxi Road,
Shanghai, PRC 200030
Phone: +86-21-6354-6323
Fax: +86-21-6354-6325
e-mail:
chinasales@power.com

INDIA

#1, 14th Main Road
Vasanthanagar
Bangalore-560052
India
Phone: +91-80-4113-8020
Fax: +91-80-4113-8023
e-mail:
indiasales@power.com

SINGAPORE

51 Newton Road,
#19-01/05 Goldhill Plaza
Singapore, 308900
Phone: +65-6358-2160
Fax: +65-6358-2015
e-mail:
singaporesales@power.com

CHINA (SHENZHEN)

17/F, Hivac Building, No. 2, Keji
Nan 8th Road, Nanshan District,
Shenzhen, China, 518057
Phone: +86-755-8672-8689
Fax: +86-755-8672-8690
e-mail: chinasales@power.com

ITALY

Via Milanese 20, 3rd. Fl.
20099 Sesto San Giovanni (MI)
Italy
Phone: +39-024-550-8701
Fax: +39-028-928-6009
e-mail: eurosales@power.com

TAIWAN

5F, No. 318, Nei Hu Rd.,
Sec. 1
Nei Hu District
Taipei 11493, Taiwan R.O.C.
Phone: +886-2-2659-4570
Fax: +886-2-2659-4550
e-mail: taiwansales@power.com

GERMANY

(AC-DC/LED Sales)
Lindwurmstrasse 114
80337, Munich
Germany
Phone: +49-895-527-39110
Fax: +49-895-527-39200
e-mail: eurosales@power.com

JAPAN

Kosei Dai-3 Building
2-12-11, Shin-Yokohama,
Kohoku-ku, Yokohama-shi,
Kanagawa 222-0033
Japan
Phone: +81-45-471-1021
Fax: +81-45-471-3717
e-mail: japansales@power.com

UK

Cambridge Semiconductor,
a Power Integrations company
Westbrook Centre, Block 5, 2nd
Floor
Milton Road
Cambridge CB4 1YG
Phone: +44 (0) 1223-446483
e-mail: eurosales@power.com

